

Portable compact disc player

Service Service Service

AZT9240
all versions



PRODUCT FAMILY ULTRA – TUNER

Service Manual



TABLE OF CONTENTS

Technical specification	1-1..1-2
Features	1-2
Connections and controls	1-3
Instruction For Use (excerpt)	1-4..1-6
Accessories	1-7
Safety & Warnings	1-8

Service hints

Repair positions	2-1
Dismantling CD-door	2-1
Handling chip components	2-2
Service tools	2-2

Pin description of ICs	3-1..3-3
Start-up procedure	3-4
Service Test Program	3-5..3-6
Blockdiagram	3-7

Circuit diagrams

Supply part	4-1
CD part	4-2
Control part	4-3
Audio part	4-4
Tuner part (for orientation only)	4-5

Printed circuit board

Componentside view	4-6
Copperside view	4-7
Tuner board (for orientation only)	4-8
Exploded view	5-1
Mechanical partslist	5-2
Electrical partslist	6-1..6-4

© Copyright 2001 Philips Consumer Electronics B.V. Eindhoven, The Netherlands
All rights reserved. No part of this publication may be reproduced, stored in a retrieval system or transmitted, in any form or by any means, electronic, mechanical, photocopying, or otherwise without the prior permission of Philips.

Published by PW 0110 Service Audio Printed in The Netherlands Subject to modification

GB 3103 785 25070

CS 46 741



PHILIPS

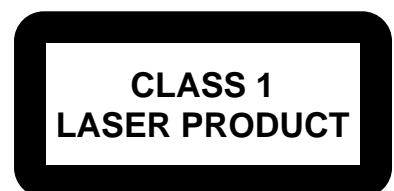

TECHNICAL SPECIFICATION

General

Dimensions (WxHxD) : 128x34x139.5mm
Weight without batteries : 220g

Laser

Output power : <5mW (3mW typ.)
Wavelength : 780nm

Shock resistance

+X/-X direction : $\geq 2.5g$
+Y/-Y direction : $\geq 2.5g$
+Z/-Z direction : $\geq 2.0g$

Power supply modes

SUPPLY MODE	Voltage range	
	CD	Tuner
DC-IN socket	2.5 - 6.0V	
Primary batteries 2 x LR6	1.6 - 3.6V	1.9 - 3.6V
Rechargeable batteries AY3362 (1200mAh)	1.6 - 3.6V	1.9 - 3.6V

Battery lifetime

BATTERY TYPE	CD MODE ESP OFF	CD MODE ESP ON	TUNER MODE
Primary batteries 2 x LR6	$\geq 12h$ (18h typ.)	$\geq 12h$ (18h typ.)	$\geq 50h$ (70h typ.)
Rechargeable batteries AY3362 (1200mAh)	$\geq 7h$ (10h typ.)	$\geq 7h$ (10h typ.)	$\geq 25h$ (35h typ.)

Battery level detection – CD mode

DETECTION LEVEL	Primary batteries	Rechargeable batteries
Battery empty	1.8V +100/-50mV	1.8V +100/-50mV
Battery weak 1	battery empty level + 0.75V $\pm 100mV$	battery empty level + 0.7V $\pm 100mV$
Battery weak 2	battery empty level + 0.45V $\pm 100mV$	battery empty level + 0.5V $\pm 100mV$
Battery weak 3	battery empty level + 0.3V $\pm 100mV$	battery empty level + 0.3V $\pm 100mV$

Battery level detection – Tuner mode

DETECTION LEVEL	Primary batteries	Rechargeable batteries
Battery empty	2.0V +100/-50mV	2.0V +100/-50mV
Battery weak 1	battery empty level + 0.7V $\pm 100mV$	battery empty level + 0.5V $\pm 100mV$
Battery weak 2	battery empty level + 0.45V $\pm 100mV$	battery empty level + 0.35V $\pm 100mV$
Battery weak 3	battery empty level + 0.2V $\pm 100mV$	battery empty level + 0.2V $\pm 100mV$

Current consumption

OPERATION MODE	DC-IN SUPPLY (4.5V)		BATT. SUPPLY (2.25V)	
	ESP OFF	ESP ON	ESP OFF	ESP ON
CD Play mode	110mA typ.	100mA typ.	130mA typ.	120mA typ.
CD Jump mode	220mA typ.	220mA typ.	300mA typ.	400mA typ.
TUNER mode	30mA typ.		30mA typ.	
Stand-by (excl. recharge)	15mA typ.		350 μ A typ.	

Charge section (not on all versions)

Charge current : 250mA $\pm 10\%$
Charge time for 80% AY3362 : 4.0h nom.
Max. charge time (μ P controlled) : 7h
Temperature protection : 50°C $\pm 5^\circ$ C

Tuner (not on all versions)

	FM	AM
Tuning range	87.5-108MHz	531-1602kHz 530-1700kHz for /17
IF	10.7MHz	450kHz
Sensitivity 26dB S/N, m=30% -3dB limiting point	$\leq 22dBf$ (15dBf typ.) $\leq 26dBf$ (15dBf typ.)	$\leq 5mV/m$ (3mV/m typ.)
Frequency grid	100kHz 50kHz for /17	9kHz 10kHz for /17
Distortion	$\leq 7\%$ (2% typ.) rf=1mV, $\Delta f=75kHz$	$\leq 7\%$ (2% typ.) rf=1mV, m=80%
Image rejection ratio	$\geq 20dB$ (25dB typ.)	$\geq 28dB$ (40dB typ.)

Headphone out (measured with 16 Ω load, DBB/ESP off)

Output power (THD=10%)
/17 version only : 2x6mW (+1/-3dB)
all other versions : 2x2.5mW (+1/-3dB)
Frequency response CD (1mW) : 100Hz-20kHz within 6dB
Frequency response AM (1mW) : 100Hz-1.5kHz within 6dB
Frequency response FM (1mW) : 100Hz-12.5kHz within 6dB
S/N ratio CD (unwght) : $\geq 78dB$ (81dB typ.)
S/N ratio CD (A-wght) : $\geq 82dB$ (84dB typ.)
S/N ratio AM (A-wght) : $\geq 40dB$ (45dB typ.)
S/N ratio FM (A-wght) : $\geq 45dB$ (55dB typ.)
THD+N CD (1kHz, 1mW) : $\leq 1\%$ (0.2% typ.)
THD+N AM/FM (1kHz, 1mW) : $\leq 7\%$ (2% typ.)
Channel crosstalk (1kHz, no load) : $\leq -24dB$ (-44dB typ.)
Channel unbalance (-40dB) : $\leq 5dB$
Volume attenuation (1kHz) : $\geq 60dB$

Dynamic Bass Boost DBB

DBB STAGE	Frequency response		
	63kHz	1kHz	10kHz
DBB 1	+6dB $\pm 2dB$	0dB $\pm 2dB$	0dB $\pm 2dB$
DBB 2	+9dB $\pm 2dB$	0dB $\pm 2dB$	+5dB $\pm 2dB$

Measurement setup CD

Use Audio Signal disc SBC429 4822 397 30184

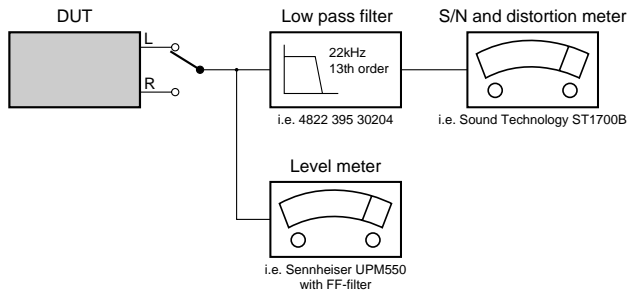

Measurement setup FM

Use bandpass filter to eliminate hum (50Hz, 100Hz) and disturbance from pilotone (19kHz, 38kHz).

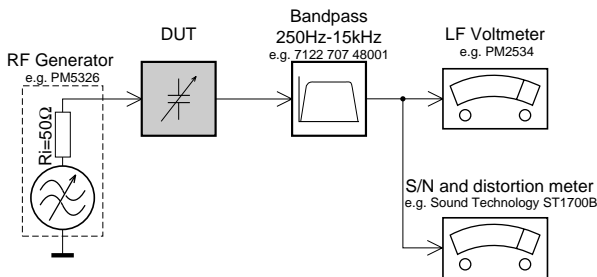

Measurement setup AM

To avoid admospheric interference all AM measurements have to be carried out in a Farraday's cage. Use bandpass filter (or at least a high pass filter with 250Hz) to eliminate hum (50Hz, 100Hz).

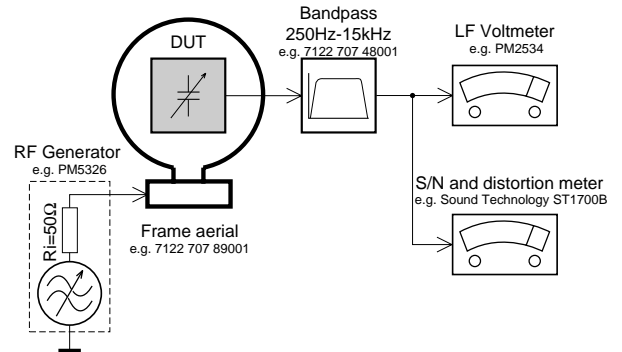

FEATURE OVERVIEW

FEATURES OF CD-PORTABLE PRODUCT FAMILY "ULTRA - TUNER"	AZT9240 (all versions)
TUNER FM / MW / SW	● / ● / -
CD-REWRITABLE COMPATIBILITY	●
ELECTRONIC SKIP PROTECTION	45s
ESP DRAM SIZE	16Mbit
HOLD / RESUME FUNCTION	● / ●
DBB STAGES	2
ACOUSTIC FEEDBACK	●
PROGRAM MEMORY	99
RECHARGE FUNCTION NiCd / NiMH	● / ●
CORD REMOTE CONTROL PREPARED	-
DISPLAY BACKLIGHT	-
LINE / DIGITAL OUTPUT	- / -

CONNECTIONS AND CONTROLS

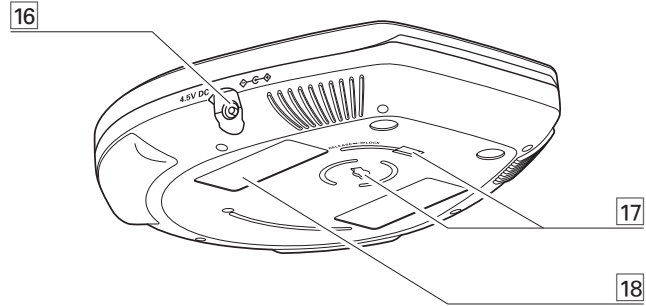
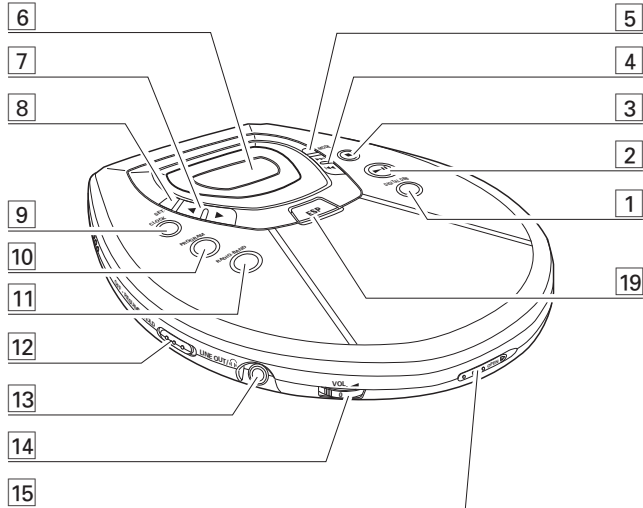

- 1 **DIGITAL DBB** ... **DIGITAL DYNAMIC BASS BOOST** switches the bass enhancement on and off
- 2 **▶||** switches the player on, starts or pauses CD play
- 3 **■** stops CD play, clears a CD program or switches the player off
- 4 **▶▶** skips and searches CD tracks forwards, selects the next preset radio station
◀◀ skips and searches CD tracks backwards, selects the previous preset radio station
- 5 **MODE** selects the different playing possibilities: shuffle, shuffle repeat all, repeat, repeat all and *SCAN*
- 6 display
- 7 **▲** tunes to radio stations upwards, sets the time upwards
▼ tunes to radio stations downwards, sets the time downwards
- 8 **SET** activates / confirms the current time setting, activates / confirms the alarm time setting

- 9 **CLOCK** switches to clock or alarm clock display
- 10 **PROGRAM** programs CD tracks and radio stations, reviews the program
- 11 **RADIO-BAND** ... switches the radio on, selects a waveband
- 12 **RESUME** stores the last position of a CD track played
HOLD locks all buttons
OFF switches RESUME and HOLD off
- 13 **LINE OUT** / 3.5 mm headphone socket, socket to connect the player to another analogue audio input of an additional appliance, remote control socket
- 14 **VOL** adjusts the volume
- 15 **OPEN** **▶** opens the CD lid
- 16 **4.5V DC** socket for external power supply
- 17 belt clip holder
- 18 typeplate
- 19 **ESP** **ELECTRONIC SKIP PROTECTION** ensures continuous CD playback regardless of vibrations and shocks, switches the alarm function on and off

INSTRUCTION FOR USE (excerpt)

Programming track numbers

You can select up to 99 tracks and store them in memory in a desired sequence. Any track can be stored more than once.

- 1 While playback is stopped, select a track with ◀◀ or ▶▶.
 - 2 Press PROGRAM to store the track.
 - PROGRAM lights up; the track number programmed and P with the total number of stored tracks are displayed.
 - 3 Select and store all desired tracks in this way.
 - 4 Press ▶▶ to start playback of your selected tracks.
 - PROGRAM is shown and playback starts.
- You can review the program by pressing PROGRAM for more than 2 seconds.
 - The display shows all stored tracks in sequence.

Notes:

- If you press PROGRAM and there is no track selected, SELECE is displayed.
- If you try to store more than 99 tracks, FULL is displayed.

Clearing the program

- 1 If necessary, press ■ to stop playback.
- 2 Press ■ to clear the program.
 - CLEAR is displayed once, PROGRAM goes off and the program is cleared.

Notes:

- The program will also be cleared if you
 - interrupt the power supply or
 - open the CD lid.

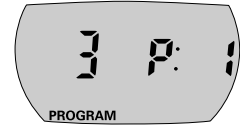
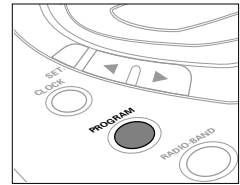

Radio play

You can tune to any FM or MW station automatically or manually. Stereo stations are indicated by ST.

- 1 Press RADIO-BAND to switch the radio on.
- 2 Press RADIO-BAND if necessary repeatedly to select the desired waveband.
 - FM 1, FM 2, FM 3, FM 4 or MW is shown.

Tuning to radio stations automatically

- 1 Keep ▲ or ▼ pressed for at least 1 second.
 - The radio tunes to a station with sufficient strength and radio play starts.
 - ⌂ (for "automatic search") and the current waveband and frequency are displayed.
- 2 Repeat searching until you find the desired radio station.

Tuning to radio stations manually

- 1 Keep ▲ or ▼ pressed.
- 2 Release ▲ or ▼, then briefly press ▲ or ▼ again when you are close to the desired frequency.
- 3 Briefly press ▲ or ▼ repeatedly until you reach the desired frequency.
 - Radio play starts. The current waveband and frequency are displayed.

- To switch from radio play to CD play press ▶▶.
- Press ■ to switch the radio off.

Note: In case of interferences in stereo mode press -MODE to switch to mono.

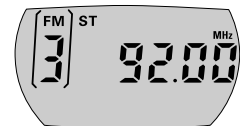
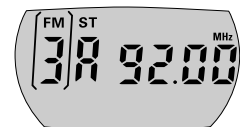
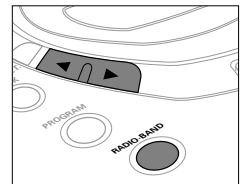

Antennas

- FM: The headphone wire is used as FM antenna. If necessary move it for optimum reception.
- MW: The internal MW antenna is directed by turning the player.

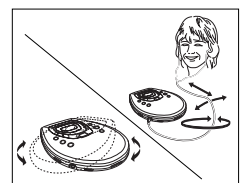

Storing radio stations

You can store up to 30 radio stations.

- 1 Tune to a desired radio station and press PROGRAM.
- 2 Press ◀ or ▶ if necessary repeatedly to select the number that should be assigned to this radio station.
- 3 Press PROGRAM while PRESET is blinking to confirm the storing.
 - PRESET, the waveband, the frequency and the preset number of the stored station are displayed.
- 4 Store all desired stations this way.

Note: Already stored stations can be recognized by the indicator PRESET and the preset number.

Tuning to a stored radio station

- 1 Select the waveband.
- 2 Press ◀ or ▶ if necessary repeatedly to select the preset number of the desired radio station.
 - Radio play starts. PRESET, the waveband, the frequency and the preset number of the stored station are displayed.

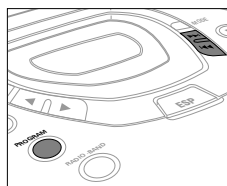

Time setting

Your player has a built-in clock. However CD or tuner play is not conditional upon the time setting.

- 1 Keep SET- pressed for approximately 2 seconds.
 - The clock digits 00:00 flash.
 - 2 Keep ▲ or ▼ pressed, then briefly press ▲ or ▼ again repeatedly within 5 seconds to set the current time.
 - The current time is displayed.
 - 3 Press SET- three times or do not press any key for 5 seconds.
 - The current time is set and the time display goes off.
- To switch to the clock display during CD or tuner play, press CLOCK.
 - The current time is displayed for 5 seconds.

Notes:

- When the player is supplied by batteries do not remove the batteries during radio play, otherwise time settings will be lost and will have to be readjusted.
- If the power supply is interrupted for longer than 1 minute, all time settings will be lost and will have to be readjusted.

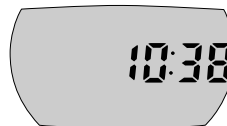
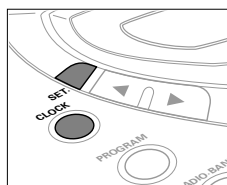

Alarm time setting

Provided the current time has been set, your player can be used as an alarm clock.

- 1 Keep SET- pressed for approximately 2 seconds, then briefly press SET- again.
 - AL is displayed and the alarm clock digits 00:00 flash.
 - 2 Press ▲ or ▼ repeatedly within 5 seconds to set the alarm time.
 - is shown and the alarm time is displayed.
 - 3 Press SET- twice or do not press any key for 5 seconds.
 - The alarm time is set and the alarm display goes off.
- To switch to the alarm clock display during CD or tuner play, press CLOCK twice.
 - is shown and the alarm time is displayed for 5 seconds.

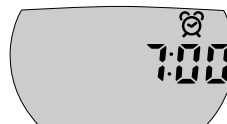

Troubleshooting

PROBLEM	POSSIBLE CAUSE	SOLUTION
No power, playback does not start	Batteries Batteries inserted incorrectly	Insert the batteries correctly
	Batteries are empty	Change the batteries
	Contact pins are dirty	Clean them with a cloth
	Mains adapter Loose connection	Connect the adapter securely
	In-car use Cigarette lighter is not powered when ignition is off	Switch on ignition or insert batteries
<i>no disc</i> indication	CD-RW (CD-R) is not recorded properly	Use FINALIZE on the CD Recorder to complete the recording
<i>no disc</i> indication	The CD is badly scratched or dirty	Replace or clean the CD
	CD is not or incorrectly inserted	Insert a CD, label upwards
	The laser lens is steamed up	Wait until the lens has cleared
<i>Hold</i> indication and/or no reaction to controls	HOLD is activated	Deactivate Hold
	Electrostatic discharge	Disconnect the set from power supply or take out the batteries for a few seconds
CD skips tracks	The CD is damaged or dirty	Replace or clean the CD
	RESUME, SHUFFLE or PROGRAM is active	Switch RESUME, SHUFFLE or PROGRAM off
No sound or bad sound quality	PAUSE is activated	Press ►
	Loose, wrong or dirty connections	Check and clean connections
	Volume is not adjusted	Adjust the volume
	Malfunctions due to vicinity of active mobile phones	Keep the player away from active mobile phones
	Strong magnetic fields near the player	Change the player's position or connections
	In-car use Cassette adapter is inserted incorrectly	Insert the cassette adapter correctly
	Temperature inside the car is too high/low	Let the player adjust to the temperature
	Cigarette lighter socket is dirty	Clean the cigarette lighter socket
Wrong playback direction of the car cassette player's autoreverse feature	Change the autoreverse direction	
Poor radio reception	Weak radio signal	Direct the antenna for optimum reception
	Interference caused by electric equipment like TVs, computers, engines etc.	Keep the player away from electric equipment
Alarm does not work	Alarm time is not set / alarm is not activated	Set the alarm time / activate the alarm
Malfunctions, loss of time settings	Continued operation with weak batteries	Change batteries, readjust settings

ACCESSORIES

ACCESSORIES FOR CD-PORTABLE PRODUCT FAMILY "ULTRA - TUNER"		AZT9240				
		/00	/01	/17	/17p	/19
AYT3170/00 AC/DC Adaptor	3140 118 32710	X				
AYT3170/02 AC/DC Adaptor	3140 118 32720		X			
AYT3170/17 AC/DC Adaptor	3140 118 32750			X	X	
AYT3170/19 AC/DC Adaptor	local supplier					X
AY3362/00 Rechargeable battery NiMH	3103 308 84120	X	X			X
AY3464 HIFI CORD (3.5mm → cinch, L-plug)	4822 320 11881	O	O	O	O	O
AY3501/00 Car Adaptor Cassette	4822 397 10059	O	O	O	O	O
AY3545/00 Car DC/DC Converter	4822 219 10033	O	O	O	O	O
SBC HE545/77 Earphone (L-plug)	9082 100 00268	X	X			X
SBC HL350/77 Headphone (L-plug)	9082 100 00235			X	X	
BELT-CLIP	3103 304 70250	X	X	O	O	X

X...supplied with the set, O...optional available

SAFETY & WARNINGS

(GB) WARNING

All ICs and many other semiconductors are susceptible to electrostatic discharges (ESD). Careless handling during repair can reduce life drastically.

When repairing, make sure that you are connected with the same potential as the mass of the set via a wristband with resistance. Keep components and tools at this potential.

(F) ATTENTION

Tous les IC et beaucoup d'autres semi-conducteurs sont sensibles aux décharges statiques (ESD). Leur longévité pourrait être considérablement écourtée par le fait qu'aucune précaution n'est prise à leur manipulation.

Lors de réparations, s'assurer de bien être relié au même potentiel que la masse de l'appareil et enfilez le braceleterti d'une résistance de sécurité.

Veiller à ce que les composants ainsi que les outils que l'on utilise soient également à ce potentiel.

(D) WARNUNG

Alle ICs und viele andere Halbleiter sind empfindlich gegenüber elektrostatischen Entladungen (ESD). Unsorgfältige Behandlung im Reparaturfall kann die Lebensdauer drastisch reduzieren.

Sorgen Sie dafür, daß Sie im Reparaturfall über ein Pulsarmband mit Widerstand mit dem Massepotential des Gerätes verbunden sind.

Halten Sie Bauteile und Hilfsmittel ebenfalls auf diesem Potential.

ESD



(NL) WAARSCHUWING

Alle IC's en vele andere halfgeleiders zijn gevoelig voor electrostatische ontladingen (ESD).

Onzorgvuldig behandelen tijdens reparatie kan de levensduur drastisch doen verminderen. Zorg ervoor dat u tijdens reparatie via een polsband met weerstand verbonden bent met hetzelfde potentiaal als de massa van het apparaat.

Houd componenten en hulpmiddelen ook op ditzelfde potentiaal.

(I) AVVERTIMENTO

Tutti IC e parecchi semi-conduttori sono sensibili alle scariche statiche (ESD).

La loro longevità potrebbe essere fortemente ridatta in caso di non osservazione della più grande cauzione alla loro manipolazione. Durante le riparazioni occorre quindi essere collegato allo stesso potenziale che quello della massa del'apparecchio tramite un braccialetto a resistenza.

Assicurarsi che i componenti e anche gli utensili con quali si lavora siano anche a questo potenziale.

(GB) AVAILABLE ESD PROTECTION EQUIPMENT :

anti-static table mat large 1200x650x1.25mm
small 600x650x1.25mm

anti-static wristband

connection box (3 press stud connections, 1MΩ)

extendible cable (2m, 2MΩ, to connect wristband to connection box)

connecting cable (3m, 2MΩ, to connect table mat to connection box)

earth cable (1MΩ, to connect any product to mat or to connection box)

KIT ESD3 (combining all 6 prior products - small table mat)

wristband tester

4822 466 10953

4822 466 10958

4822 395 10223

4822 320 11307

4822 320 11305

4822 320 11306

4822 320 11308

4822 310 10671

4822 344 13999

(GB)

Safety regulations require that the set be restored to its original condition and that parts which are identical with those specified be used.

Safety components are marked by the symbol

(F)

Les normes de sécurité exigent que l'appareil soit remis à l'état d'origine et que soient utilisées les pièces de rechange identiques à celles spécifiées.

Les composants de sécurité sont marqués

(D)

Bei jeder Reparatur sind die geltenden Sicherheitsvorschriften zu beachten. Der Originalzustand des Gerätes darf nicht verändert werden. Für Reparaturen sind Originalersatzteile zu verwenden.

Sicherheitsbauteile sind durch das Symbol

SAFETY



(NL)

Veiligheidsbepalingen vereisen, dat het apparaat in zijn oorspronkelijke toestand wordt teruggebracht en dat onderdelen, identiek aan de gespecificeerde, worden toegepast. De Veiligheidsonderdelen zijn aangeduid met het symbool

(I)

Le norme di sicurezza estigono che l'apparecchio venga rimesso nelle condizioni originali e che siano utilizzati i pezzi di ricambio identici a quelli specificati.

Componenti di sicurezza sono marcati con

(GB) **DANGER:** Invisible laser radiation when open.
AVOID DIRECT EXPOSURE TO BEAM.



(S) Varning !

Osynlig laserstrålning när apparaten är öppnad och spårren är urkopplad. Betrakta ej strålen.

(DK) Advarsel !

Usynlig laserstrålning ved åbning når sikkerhedsafbrydere er ude af funktion. Undgå udsættelse for strålning.

(FIN) Varoitus !

Avatussa laitteessa ja suojalukituksen ohitettaessa olet alltiina näkymättömälle laserisäteilylle. Älä katso säteeseen !

(GB)

After servicing and before returning the set to customer perform a leakage current measurement test from all exposed metal parts to earth ground, to assure no shock hazard exists.

The leakage current must not exceed 0.5mA.

(F)

"Pour votre sécurité, ces documents doivent être utilisés par des spécialistes agréés, seuls habilités à réparer votre appareil en panne".

SERVICE HINTS

REPAIR POSITION COPPERSIDE



To get access to the copperside of the printed board assembly proceed as follows:

1. Remove the bottom screws (6x)
2. Lift the bottom-cabinet
3. Supply the unit via external DC-socket
4. Take care that the door switch is closed during measurements

REPAIR POSITION COMPONENTSIDE



To get access to the componentside of the printed board assembly proceed as follows:

1. Remove the bottom screws (6x)
2. Open the CD-door
3. Lift the top-cabinet and put it backwards on the table
4. Supply the unit via the external DC-socket
5. Take care that the door switch is closed during measurements

DISMANTLING THE CD-DOOR

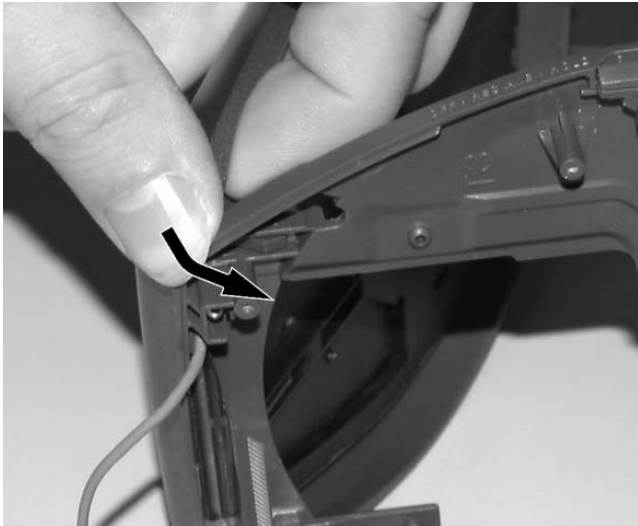

To dismantle the CD-door proceed as follows:

1. Dismantle bottom and printed board/drive assembly
2. Disconnect membrane keyboard (flex-foil connector on copperside of printed board)
3. Bend the cabinet rightwards downwards as indicated in the picture above.

Remark: Do not use screwdrivers or tools like that.
Sharp edges could damage hinge or cabinet part.

HANDLING CHIP COMPONENTS

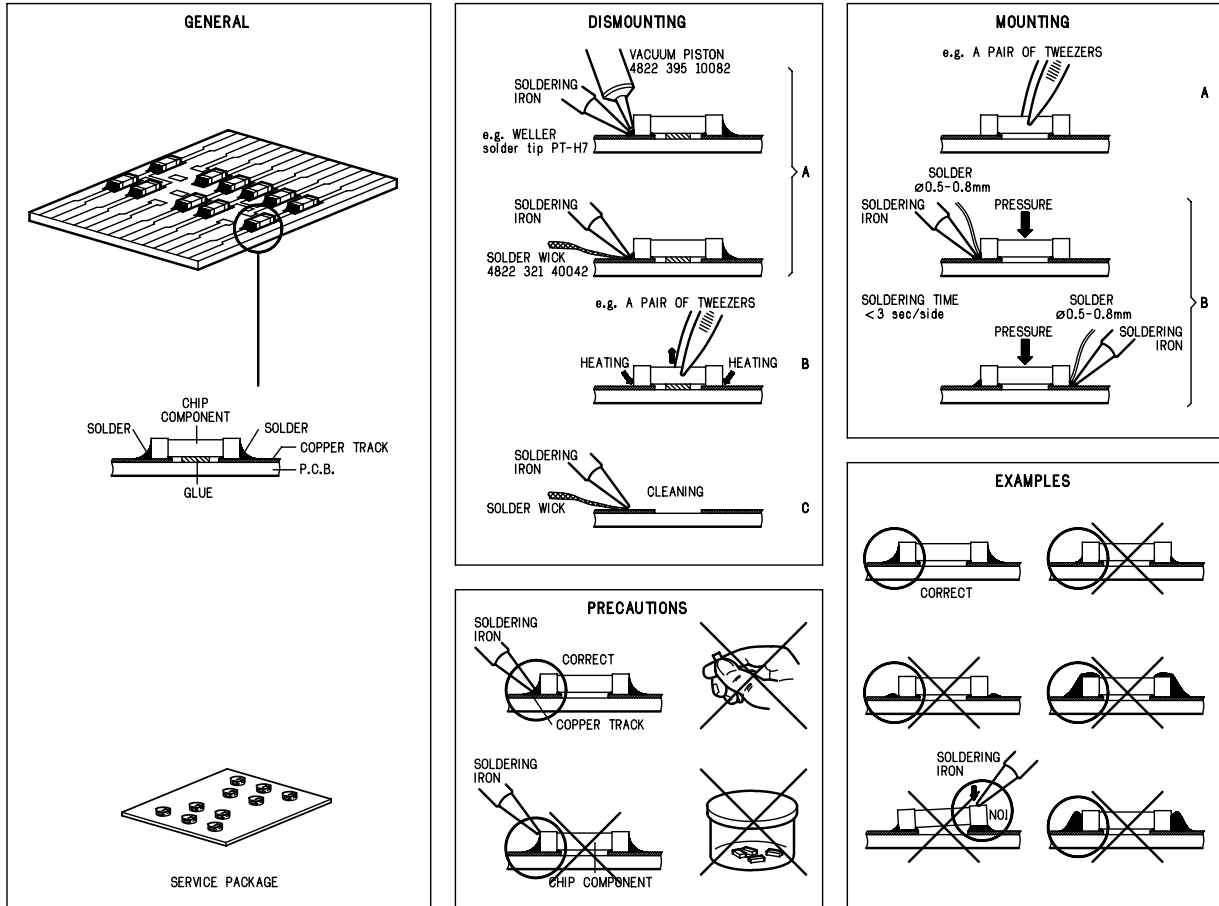

SERVICE TOOLS

Audio signal disc **SBC429**
 Playability test disc **SBC444**

Test disc **5** (disc without errors) + Test disc **5A** (disc with dropout errors, black spots and fingerprints) **SBC426/SBC426A**

4822 397 30184

4822 397 30245

4822 397 30096

ESD PROTECTION EQUIPMENT

Anti-static table mat large 1200x650x1.25mm
 small 600x650x1.25mm

Anti-static wristband

Connection box (3 press stud connections, 1MΩ)

Extendible cable (2m, 2MΩ, to connect wristband to connection box)

Connecting cable (3m, 2MΩ, to connect table mat to connection box)

Earth cable (1MΩ, to connect any product to mat or to connection box)

KIT ESD3 (combining all 6 prior products - small table mat)

Wristband tester

4822 466 10953

4822 466 10958

4822 395 10223

4822 320 11307

4822 320 11305

4822 320 11306

4822 320 11308

4822 310 10671

4822 344 13999

PIN DESCRIPTION OF INTEGRATED CIRCUITS

TZA1024 – HF-PREAMPLIFIER AND LASER SUPPLY CIRCUIT

<i>Pin</i>	<i>Name</i>	<i>Direction</i>	<i>Description</i>
1	LD	HF-preamp → CD-drive	current output to laser diode
2	VCCL	+2.7	laser supply voltage
3	CFIL	→ HF-preamp	external filter capacitor
4	MON	CD-drive → HF-preamp	laser monitor diode input
5	DIN	CD-drive → HF-preamp	central diode input
6	GND	GND	ground
7	PWRON	CD10 → HF-preamp	power-on select input
8	CMFB	+2.7 / 2	common mode feedback voltage input
9	RFFB	→ HF-preamp	external RF feedback resistor
10	RFEQO	HF-preamp →	RF amplifier output
11	CDRW	CD10 → HF-preamp	gain select input for CDDA/CDRW
12	EQSEL	CD10 → HF-preamp	equalizer/speed select input
13	VCC2	+2.7	supply voltage
14	RGADJ	GND	external laser supply gain adjust resistor

MPC17A51VM – 4-CHANNEL H-BRIDGE SERVODRIVER

<i>Pin</i>	<i>Name</i>	<i>Direction</i>	<i>Description</i>
1	VG	servo driver →	charge pump output, supply for pre-driver circuit
2	DGND	GND	digital ground for control circuit
3	CLK	→ servo driver	clock signal input
4	OE	→ servo driver	output enable
5	VLG	+2.7	power supply input for control circuit
6	VIN12	+A	power supply input for CH1 and CH2 H-bridge driver block
7	OUT1A	servo driver → focus actuator	CH1 H-bridge output A
8	PGND1	GND	power ground for CH1 H-bridge driver block
9	OUT1B	servo driver → focus actuator	CH1 H-bridge output B
10	OUT2B	servo driver → track actuator	CH2 H-bridge output B
11	PGND2	GND	power ground for CH2 H-bridge driver block
12	OUT2A	servo driver → track actuator	CH2 H-bridge output A
13	VIN1-2	+A	power supply input for CH1 and CH2 H-bridge driver block
14	CF2	→ servo driver	CH2 capacitor connection for phase compensation
15	ERR2	CD10 → servo driver	CH2 error level input (radial error signal)
16	ERR1	CD10 → servo driver	CH1 error level input (focus error signal)
17	CF1	→ servo driver	CH1 capacitor connection for phase compensation
18	VR	+1.4	reference voltage input
19	AGND	GND	analog ground for control circuit
20	CF3	→ servo driver	CH3 capacitor connection for phase compensation
21	ERR3	CD10 → servo driver	CH3 error level input (slide error signal)
22	ERR4	CD10/μP → servo driver	CH4 error level input (disc motor speed error signal)
23	CF4	→ servo driver	CH4 capacitor connection for phase compensation
24	VIN3-4	+A	power supply input for CH3 and CH4 H-bridge driver block
25	OUT4A	servo driver → disc motor	CH4 H-bridge output A
26	PGND4	GND	power ground for CH4 H-bridge driver block
27	OUT4B	servo driver → disc motor	CH4 H-bridge output B
28	OUT3B	servo driver → slide motor	CH3 H-bridge output B
29	PGND3	GND	power ground for CH3 H-bridge driver block
30	OUT3A	servo driver → slide motor	CH3 H-bridge output A
31	VIN34	+A	power supply input for CH3 and CH4 H-bridge driver block
32	VCG	+2.7	power supply input for charge pump circuit
33	C2L	→ servo driver	capacitor connection for charge pump
34	C1L	→ servo driver	capacitor connection for charge pump
35	C1H	→ servo driver	capacitor connection for charge pump
36	C2H	→ servo driver	capacitor connection for charge pump

SAA7324 – DECODER, DIGITAL SERVO IC AND D/A-CONVERTER CD10 (low voltage version)

<i>Pin</i>	<i>Name</i>	<i>Direction</i>	<i>Description</i>
1	HFREF	→ CD10	comparator common mode input
2	HFIN	→ CD10	comparator signal input
3	ISLICE	CD10 →	current feedback from data slicer
4	VSSA1	GND	analog ground 1
5	VDDA1	+2.7	analog supply voltage 1
6	IREF	CD10 →	reference current output pin
7	VRIN	CD10 →	reference voltage for servo ADC's
8	D1	CD-drive → CD10	unipolar current input (central diode signal input)
9	D2	CD-drive → CD10	unipolar current input (central diode signal input)
10	D3	CD-drive → CD10	unipolar current input (central diode signal input)
11	D4	CD-drive → CD10	unipolar current input (central diode signal input)
12	R1	CD-drive → CD10	unipolar current input (satellite diode signal input)
13	R2	CD-drive → CD10	unipolar current input (satellite diode signal input)
14	VSSA2	GND	analog ground 2
15	CROUT	CD10 → X-TAL	crystal/resonator output
16	CRIN	X-TAL → CD10	crystal/resonator input
17	VDDA2	+2.7	analog supply voltage 2
18	LN	CD10 →	DAC left channel differential output - negative
19	LP	CD10 →	DAC left channel differential output - positive
20	VNEG	GND	DAC negative reference input
21	VPOS	+2.7	DAC positive reference input
22	RN	CD10 →	DAC right channel differential output - negative
23	RP	CD10 →	DAC right channel differential output - positive
24	SELPLL	+2.7	selects whether internal clock multiplier PLL is used
25	TEST1	GND	test control input 1; this pin should be tied low
26	CL16	CD10 → NPC	16.9344 MHz system clock output
27	DATA	CD10 → NPC	serial data output (3-state)
28	WCLK	CD10 → NPC	word clock output (3-state)
29	SCLK	CD10 → NPC	serial bit clock output (3-state)
30	EF	CD10 →	C2 error flag output (3-state)
31	TEST2	GND	test control input 2; this pin should be tied low
32	KILL	CD10 →	kill output (programmable; open-drain)
33	VSSD1	GND	digital ground 2
34	V2/V3	CD10 → NPC	versatile I/O: input versatile pin 2 or output versatile pin 3 (open-drain)
35	WCLI	NPC → CD10	word clock input (for data loopback to DAC)
36	SDI	NPC → CD10	serial data input (for data loopback to DAC)
37	SCLI	NPC → CD10	serial bit clock input (for data loopback to DAC)
38	RESETn	NPC → CD10	power-on reset input (active low)
39	SDA	µP ↔ CD10	microcontroller interface data I/O line (open-drain output)
40	SCL	µP → CD10	microcontroller interface clock line input
41	RAB	µP → CD10	microcontroller interface R/W and load control line input (4-wire bus mode)
42	SILD	µP → CD10	microcontroller interface R/W and load control line input (4-wire bus mode)
43	STATUS	CD10 →	servo interrupt request line/decoder status register output (open-drain)
44	TEST3	GND	test control input 3; this pin should be tied low
45	RCK	→ CD10	subcode clock input
46	SUB	CD10 →	P-to-W subcode bits output (3-state)
47	SFSY	CD10 → µP	subcode frame sync output (3-state)
48	SBSY	CD10 → NPC	subcode block sync output (3-state)
49	CL11/4	CD10 →	11.2896 MHz or 4.2336 MHz (for microcontroller) clock output
50	VSSD2	GND	digital ground 3
51	DOBM	CD10 →	bi-phase mark output (externally buffered; 3-state)
52	VDDD1P	+2.7	digital supply voltage 2 for periphery
53	CFLG	CD10 →	correction flag output (open-drain)
54	RA	CD10 → servo driver	radial actuator output
55	FO	CD10 → servo driver	focus actuator output
56	SL	CD10 → servo driver	slide control output
57	VDDD2C	+2.7	digital supply voltage 3 for core
58	VSSD3	GND	digital ground 4
59	MOTO1	CD10 →	motor output 1; versatile (3-state)
60	MOTO2	CD10 →	motor output 2; versatile (3-state)
61	V4	CD10 → HF-preamp	versatile output pin 4
62	V5	CD10 → HF-preamp	versatile output pin 5
63	V1	innerswitch → CD10	versatile input pin 1
64	LDON	CD10 → HF-preamp	laser drive on output (open-drain)

SM5903BF – COMPRESSION-TYPE ANTI-SHOCK MEMORY CONTROLLER NPC

<i>Pin</i>	<i>Name</i>	<i>Direction</i>	<i>Description</i>
1	VDD2	+2.7	supply voltage
2	UC1	NPC ↔	μP interface extension I/O line 1
3	UC2	NPC ↔	μP interface extension I/O line 2
4	UC3	NPC ↔	μP interface extension I/O line 3
5	UC4	NPC ↔	μP interface extension I/O line 4
6	UC5	NPC ↔	μP interface extension I/O line 5
7	NC	NPC →	digital audio interface output
8	NTEST	+2.7	test pin
9	CLK	CD10 → NPC	16.9344MHz clock input
10	VSS	GND	ground
11	YSRDATA	CD10 → NPC	audio serial data input
12	YLCK	CD10 → NPC	audio serial L/R clock input
13	YSCK	CD10 → NPC	audio serial bit clock input
14	ZSCK	NPC → CD10	audio serial bit clock output
15	ZLCK	NPC → CD10	audio serial L/R clock output
16	ZSRDATA	NPC → CD10	audio serial data output
17	YFLAG	CD10 → NPC	signal processor IC RAM overflow flag
18	YFCLK	GND	crystal-controlled frame clock input
19	YBLKCK	CD10 → NPC	subcode block clock signal output
20	RESET	μP → NPC	system reset input (active low)
21	ZSENSE	NPC → μP	μP interface status output
22	VDD1	+2.7	supply voltage
23	YDMUTE	GND	forced mute input
24	YMLD	μP → NPC	μP interface latch clock input
25	YMDATA	μP → NPC	μP interface serial data input
26	YMCLK	μP → NPC	μP interface shift clock input
27	OE	NPC → DRAM	DRAM OE control output (active low)
28	CAS	NPC → DRAM	DRAM CAS control output (active low)
29	D2	NPC ↔ DRAM	DRAM data input/output 2
30	D3	NPC ↔ DRAM	DRAM data input/output 3
31	D0	NPC ↔ DRAM	DRAM data input/output 0
32	D1	NPC ↔ DRAM	DRAM data input/output 1
33	WE	NPC → DRAM	DRAM WE control output (active low)
34	RAS	NPC → DRAM	DRAM RAS control output (active low)
35	A9	NPC → DRAM	DRAM address output 9
36	A8	NPC → DRAM	DRAM address output 8
37	A7	NPC → DRAM	DRAM address output 7
38	A6	NPC → DRAM	DRAM address output 6
39	A5	NPC → DRAM	DRAM address output 5
40	A4	NPC → DRAM	DRAM address output 4
41	A0	NPC → DRAM	DRAM address output 0
42	A1	NPC → DRAM	DRAM address output 1
43	A2	NPC → DRAM	DRAM address output 2
44	A3	NPC → DRAM	DRAM address output 3

TA2120FN – Stereo Headphone Amplifier

<i>Pin</i>	<i>Name</i>	<i>Direction</i>	<i>Description</i>
1	DBB NF	→ headphone-amp	NF of DBB amplifier
2	ADD OUT	headphone-amp →	output of ADD amplifier
3	RF IN	→ headphone-amp	terminal for ripple filter circuit
4	PWC	→ headphone-amp	center amplifier on/off switch (open = on)
5	VCC	+HP (+A)	positive supply voltage
6	B	headphone-amp → HP-socket	output of power amplifier
7	C	headphone-amp → HP-socket	output of center amplifier
8	A	headphone-amp → HP-socket	output of power amplifier
9	GND	GND	ground of power amplifier
10	MIX OUT	headphone-amp →	output of power amplifier (mixed)
11	ALC IN	→ headphone-amp	input terminal for ALC detector circuit
12	ALC DET	→ headphone-amp	smoothing for ALC detection (GND = ALC off, open = ALC ON)
13	ATT	→ headphone-amp	power amplifier gain switch (open/VCC = ATT off, GND = ATT on)
14	IN A	→ headphone-amp	input of power amplifier
15	IN B	→ headphone-amp	input of power amplifier
16	GND	GND	ground of input stage in power amplifier
17	BEEP IN	μP → headphone-amp	input terminal for beep sound
18	MUTE TC	→ headphone-amp	terminal for mute smoothing
19	MUTE SW	μP → headphone-amp	power mute switch (GND/open = mute off, VCC = mute on)
20	POWER	→ headphone-amp	power switch (VCC = power on, GND/open = power off)
21	BIAS	headphone-amp →	BIAS voltage
22	BIAS IN	→ headphone-amp	filter terminal for BIAS circuit
23	DBB SW	μP → headphone-amp	DBB on/off switch (open/VCC = DBB on, GND = DBB off)
24	DBB OUT	headphone-amp →	Output of DBB amplifier (terminal for filter)

START-UP PROCEDURE – FLOW CHART

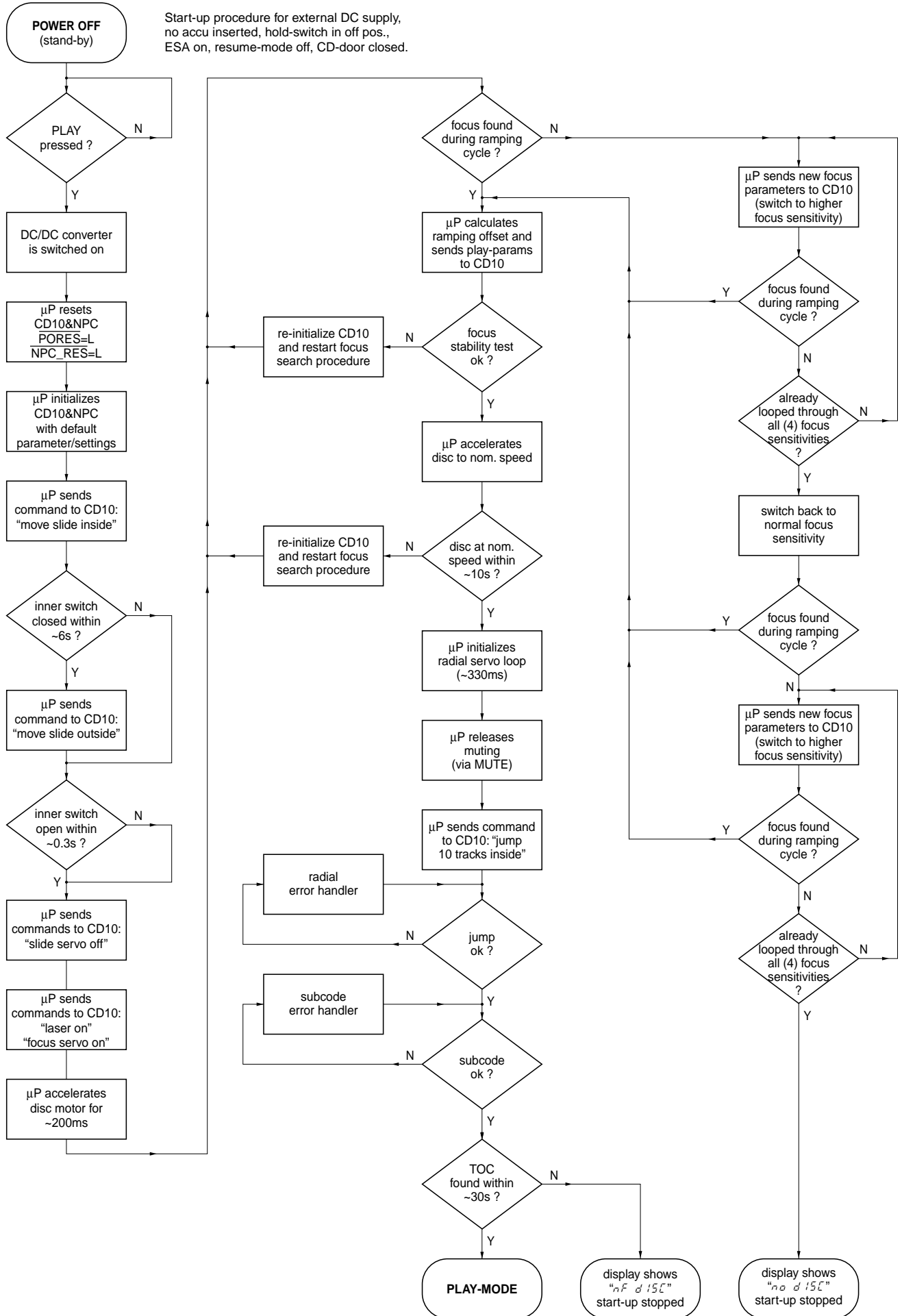

SERVICE TEST PROGRAM

1. PRELIMINARY SETUP

- To enter the service test program open the CD-door and hold the buttons "PREVIOUS" & "STOP" depressed while turning POWER ON (i.e. connecting the AC/DC adaptor).
- The display shows the software version of the built-in μP (i.e. "5 - 13"). Versions are counted from "00" onwards; that means the higher the number the newer the software.
- The program is now in the main menu – various tests can be entered by pressing the corresponding buttons (see flow chart on next page or description of available tests below).
- To exit the test program disconnect the set from the power source.

2. DISPLAY TEST

Purpose: Check functionality of display and display driver.

- To enter the display test start the service test program and press the "NEXT" button.
- The display shows test pattern1. All segments are activated for finding open circuits (see flow chart on next page).
- To jump to the next pattern press the "NEXT" button.
- The display shows test pattern2. All alternate pins (2, 4, ...) are activated for finding short circuits (see flow chart on next page).
- To jump back to test pattern1 press the "NEXT" button, to exit the display test and return to the main menu press the "STOP" button.

3. KEY TEST

Purpose: Check operation of keys.

- To enter the key test start the service test program and press the "MODE" button.
- The display shows "- -".
- Hold key depressed and check corresponding key code. Key codes can be found in table1 (see flow chart on next page).
- To exit the key test and return to the main menu press the "STOP" button.

4. TUNER TEST

Purpose: Load tuner presets with service frequencies.

- To enter the key test start the service test program and press the "RADIO" button.
- The display shows the tuner version ("EU-DPE" resp. "USA").

Note: The tuner version can be toggled by pressing buttons other than "Radio" and "STOP". Be aware that toggling versions will also toggle the tuning grid (9/10kHz). The tuner version will not be restored when leaving the service test program!

- To load the tuner presets with the default service frequencies press the "RADIO" button. Service frequencies can be found in table2 (see flow chart on next page).
- To exit the tuner test and return to the main menu press the "STOP" button.

5. PLAYBACK TEST WITH ERROR ANALYSIS

Purpose: Analyze errors that occur during playback and search for intermittent failures.

- To enter the playback test start the service test program and press the "DBB" button.
- To start the error analysis press the "PLAY" button. Note that the playback test can only be entered if the CD-door is closed.
- The set will read the TOC and start playback.

As long as the playback is free of errors the display shows track and time information like in normal play-mode. In case of errors corresponding error codes will be displayed. The meaning of these error codes can be found in table3 (see flow chart on next page).

Note: Errors can either be "fatal" or "non fatal". Fatal errors always stop the playback, non fatal errors only cause a short interruption of the music. Fatal errors are displayed as long as the set is connected to the power source, non fatal errors are displayed until a new error occurs or a button is pressed.

- To stop the playback test disconnect the set from the power source.

6. SERVO TEST

Purpose: Check door switch, inner switch of CD-drive, movement of slide and acceleration of discmotor.

- To enter the servo test start the service test program and press the "PLAY" button.
- The display shows "L d xy".
"x" indicates state of door switch;
"y" indicates state of inner switch.
x,y = "0" means switch is closed; "1" means switch is open.
- To move slide outside hold the "NEXT" button depressed.

- To move slide inside hold the "PREV" button depressed.
- To accelerate the discmotor clockwise hold the "MODE" button depressed.
- To accelerate the discmotor counter-clockwise hold the "PROG" button depressed.
- To enter the focus test press the "PLAY" button, to exit the servo test and return to the main menu press the "STOP" button.

7. FOCUS TEST

Purpose: Check movement of lens and operation of focus servo for CDDA and CDRW discs.

Since the CDRW reflects much less light than an ordinary CDDA, the gain of the HF-amplifier stage and the sensitivity of the ADC inside the Decoder&Digital Servo IC "CD10" must be adapted accordingly. The gain is switched via the CDRW input of the HF-preamplifier. The ADC-sensitivity is set via software parameters (sent from μP to "CD10"). In total, there are 4 sensitivity modes available: 1 for CDDA and 3 for CDRW. The modes are listed in table4 (see next page). In normal play-mode, the correct focus sensitivity is chosen automatically during start-up (see "Start-up procedure" on previous page). In the service test program, the sensitivity can be chosen manually in order to allow individual measurements in several modes.

- The focus servo loop is switched on and the set starts searching the focus ("focus ramping"). As soon as the focus has been found the focus servo loop is closed and the state of the focus is monitored continuously.
- If the focus is OK the display shows " F x", else "- F x".
"x" indicates the sensitivity mode. Details can be found in table4 (see flow chart on next page).
- To toggle between sensitivity modes press the "BASS" button.
- To move slide outside hold the "NEXT" button depressed.
- To move slide inside hold the "PREV" button depressed.
- To accelerate the discmotor clockwise hold the "MODE" button depressed.
- To accelerate the discmotor counter-clockwise hold the "PROG" button depressed.
- In case the focus is OK the discmotor test can be entered by pressing the "PLAY" button, to exit the focus test and return to the main menu press the "STOP" button.

8. DISCMOTOR TEST

Purpose: Check speed regulation of discmotor.

- The speed regulation is switched on and the discmotor starts rotating. If the speed reaches 75% of the nom. speed the display shows " d", else "- d".
- In parallel also the state of the focus is monitored continuously (display " F x" or "- F x").
- In case the disc speed is OK and the focus is OK the radial test can be entered by pressing the "PLAY" button, to exit the discmotor test and return to the main menu press the "STOP" button.

9. RADIAL TEST

Purpose: Check if radial loop locks and an audio signal is audible at the headphone output.

- The radial servo loop is switched on, mute is released and the audio signal is audible. If the system is on track the display shows " r", else "- r".
- In parallel also the disc speed (display " d" or "- d") and the state of the focus (display " F x" or "- F x") are monitored continuously. Note: In case of radial errors the audio output is muted and muting is not released automatically when the systems recovers from the error. "- r" remains on the display.
To open mute again press the "NEXT" or "PREV" button.
- To jump 16 tracks outside press the "NEXT" button.
- To jump 16 tracks inside press the "PREV" button.
- To exit the radial test and return to the main menu press the "STOP" button, to exit the service test program disconnect the set from the power source.

Important remark:

In radial test mode data to the DRAM is written at 1.2 times the nominal speed, and read from the DRAM at nominal speed. Because writing is done faster than reading the DRAM gets full after a certain time.

In normal play mode the system would now wait until the DRAM is partly emptied again, jump backwards and resume filling at the last written position. However, in radial test mode the jumps would disturb measurements on the radial servo loop. Therefore this function has been disabled and filling restarts immediately from the current position of the pick-up unit. As a result "jumps" are audible during playback.

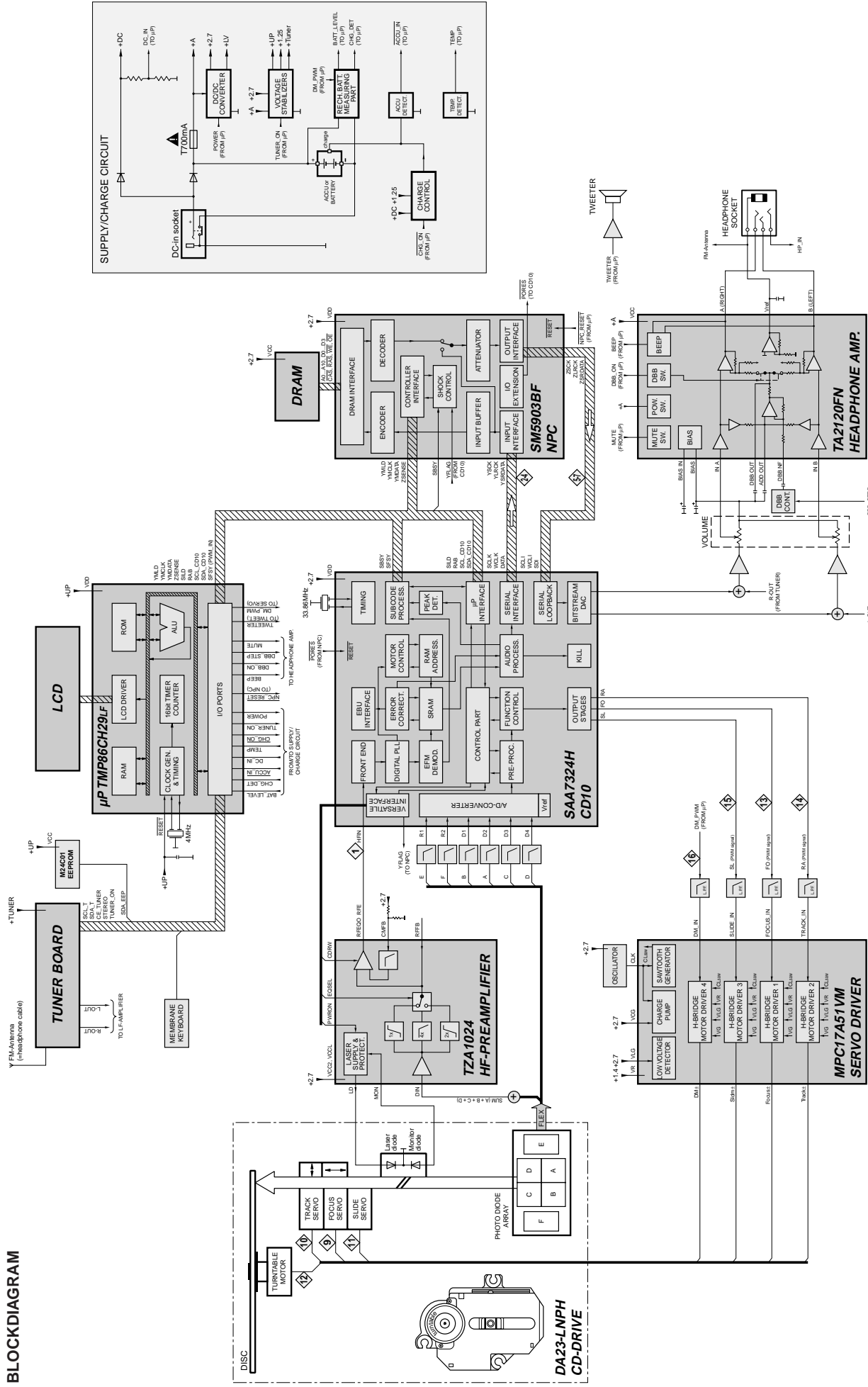

CD10 → NPC TRANSFER OF AUDIO SAMPLES VIA SERIAL INTERFACE OF CD10 AND NPC
NPC → CD10

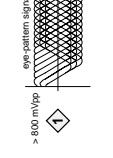
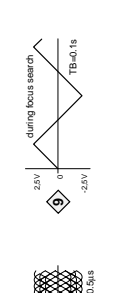
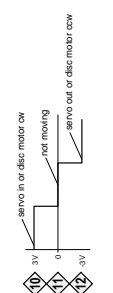
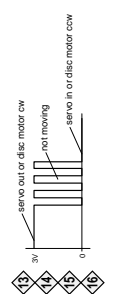
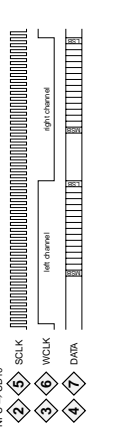

- 1291 G1
- 1292 G2
- 1293 G3
- 1294 G4
- 1295 G5
- 1296 G6
- 1297 G7
- 1298 G8
- 1299 G9
- 1300 G10
- 1301 G11
- 1302 G12
- 1303 G13
- 1304 G14
- 1305 G15
- 1306 G16
- 1307 G17
- 1308 G18
- 1309 G19
- 1310 G20
- 1311 G21
- 1312 G22
- 1313 G23
- 1314 G24
- 1315 G25
- 1316 G26
- 1317 G27
- 1318 G28
- 1319 G29
- 1320 G30
- 1321 G31
- 1322 G32
- 1323 G33
- 1324 G34
- 1325 G35
- 1326 G36
- 1327 G37
- 1328 G38
- 1329 G39
- 1330 G40
- 1331 G41
- 1332 G42
- 1333 G43
- 1334 G44
- 1335 G45
- 1336 G46
- 1337 G47
- 1338 G48
- 1339 G49
- 1340 G50
- 1341 G51
- 1342 G52
- 1343 G53
- 1344 G54
- 1345 G55
- 1346 G56
- 1347 G57
- 1348 G58
- 1349 G59
- 1350 G60
- 1351 G61
- 1352 G62
- 1353 G63
- 1354 G64
- 1355 G65
- 1356 G66
- 1357 G67
- 1358 G68
- 1359 G69
- 1360 G70
- 1361 G71
- 1362 G72
- 1363 G73
- 1364 G74
- 1365 G75
- 1366 G76
- 1367 G77
- 1368 G78
- 1369 G79
- 1370 G80
- 1371 G81
- 1372 G82
- 1373 G83
- 1374 G84
- 1375 G85
- 1376 G86
- 1377 G87
- 1378 G88
- 1379 G89
- 1380 G90
- 1381 G91
- 1382 G92
- 1383 G93
- 1384 G94
- 1385 G95
- 1386 G96
- 1387 G97
- 1388 G98
- 1389 G99
- 1390 G100
- 1391 G101
- 1392 G102
- 1393 G103
- 1394 G104
- 1395 G105
- 1396 G106
- 1397 G107
- 1398 G108
- 1399 G109
- 1400 G110

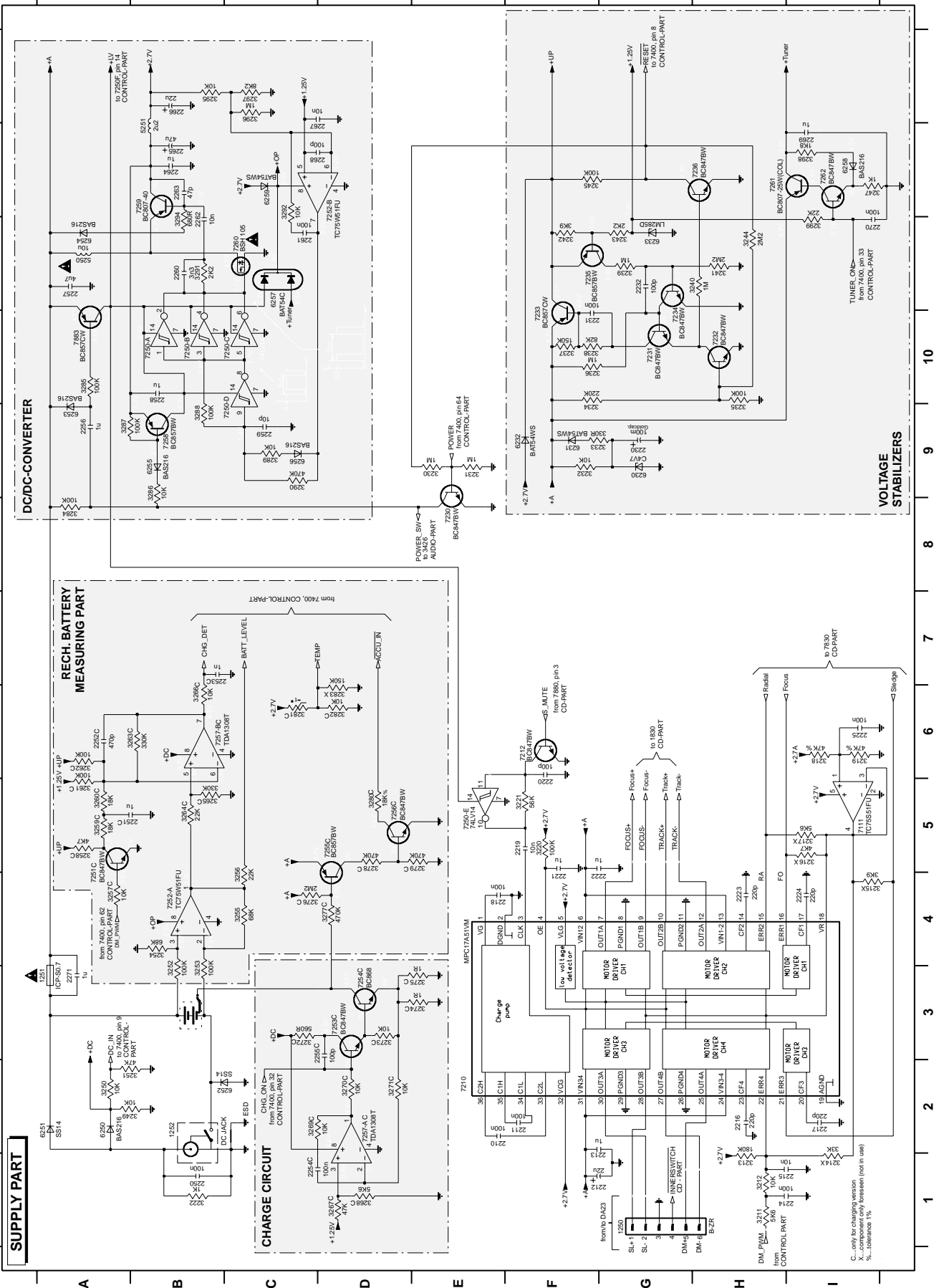

C...only for charging version
 X...component only foreseen (not in use)
 %...tolerance (%)

1401 A5
1404 F7
1405 A1
2400 C2
2401 C2
2402 D1
2403 D2
2404 E1
2405 F3
2406 F4
2407 F4
2408 F4
2409 F5
2410 F6
2411 F6
2412 F6
2413 E7
2414 A9
2415 E9
3400 C2
3401 D2
3402 E2
3403 E1
3404 E1
3405 F1
3406 F1
3407 F1
3408 F1
3409 F1
3410 E2
3411 E3
3412 F7
3413 F7
3414 E7
3415 E7
3416 D7
3417 C7
3418 A5
3419 A6
3420 A6
3421 A9
3422 A8
3423 B9
3424 D9
3425 E10
3426 F8
3427 F8
3428 F8
3429 A6
5400 E3
5401 E4
6400 A6
7250-F E1
7400 A2
7401-A E2
7401-B F2
7402-A B9
7402-B C9
7402-C B9
7403 D9
7403 D9
7404 F8

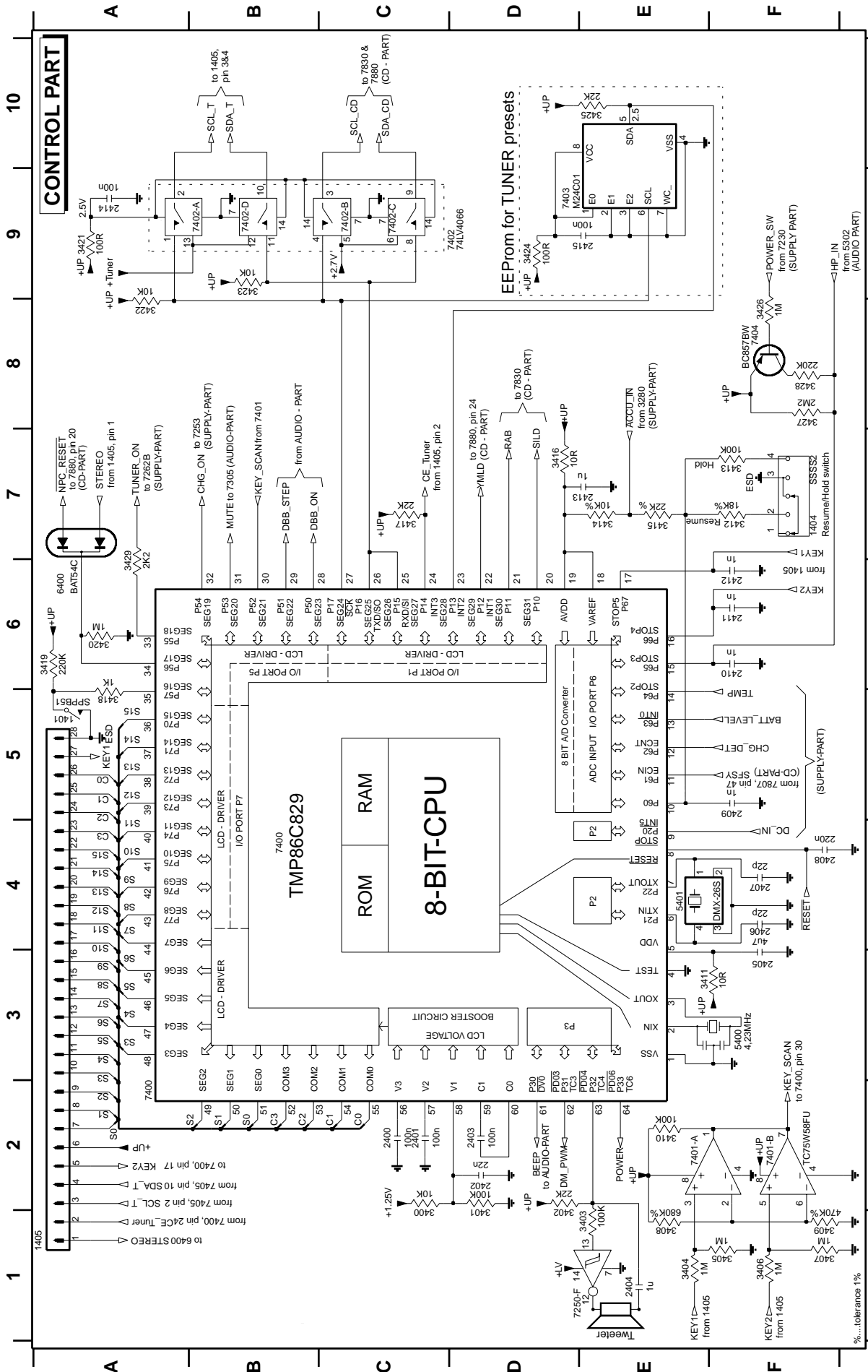

- 1300 B10
- 2304 B2
- 2309 C5
- 2314 E6
- 2319 D5
- 2325 C8
- 2330 C9
- 3303 D1
- 3308 B2
- 3313 B4
- 3320 B4
- 3325 D9
- 3330 B5
- 3335 C8
- 3340 B8
- 7303 D9
- 2300 B1
- 2305 D2
- 2310 B5
- 2315 D8
- 2320 E8
- 2325 C8
- 2330 B1
- 2335 C2
- 2340 E6
- 2345 D5
- 2350 D5
- 2355 D8
- 2360 B3
- 2365 C5
- 2370 E5
- 2375 C8
- 2380 B1
- 2385 C2
- 2390 D5
- 2395 D8
- 2300 B2
- 2305 C3
- 2310 D5
- 2315 D6
- 2320 B6
- 2325 B6
- 2330 C9
- 2335 C9
- 2340 C6
- 2345 D6
- 2350 D6
- 2355 D6
- 2360 C5
- 2365 C5
- 2370 C5
- 2375 C5
- 2380 C5
- 2385 C5
- 2390 C5
- 2395 C5
- 2300 C1
- 2305 C1
- 2310 C1
- 2315 C1
- 2320 C1
- 2325 C1
- 2330 C1
- 2335 C1
- 2340 C1
- 2345 C1
- 2350 C1
- 2355 C1
- 2360 C1
- 2365 C1
- 2370 C1
- 2375 C1
- 2380 C1
- 2385 C1
- 2390 C1
- 2395 C1
- 2300 C2
- 2305 C2
- 2310 C2
- 2315 C2
- 2320 C2
- 2325 C2
- 2330 C2
- 2335 C2
- 2340 C2
- 2345 C2
- 2350 C2
- 2355 C2
- 2360 C2
- 2365 C2
- 2370 C2
- 2375 C2
- 2380 C2
- 2385 C2
- 2390 C2
- 2395 C2
- 2300 C3
- 2305 C3
- 2310 C3
- 2315 C3
- 2320 C3
- 2325 C3
- 2330 C3
- 2335 C3
- 2340 C3
- 2345 C3
- 2350 C3
- 2355 C3
- 2360 C3
- 2365 C3
- 2370 C3
- 2375 C3
- 2380 C3
- 2385 C3
- 2390 C3
- 2395 C3
- 2300 C4
- 2305 C4
- 2310 C4
- 2315 C4
- 2320 C4
- 2325 C4
- 2330 C4
- 2335 C4
- 2340 C4
- 2345 C4
- 2350 C4
- 2355 C4
- 2360 C4
- 2365 C4
- 2370 C4
- 2375 C4
- 2380 C4
- 2385 C4
- 2390 C4
- 2395 C4
- 2300 C5
- 2305 C5
- 2310 C5
- 2315 C5
- 2320 C5
- 2325 C5
- 2330 C5
- 2335 C5
- 2340 C5
- 2345 C5
- 2350 C5
- 2355 C5
- 2360 C5
- 2365 C5
- 2370 C5
- 2375 C5
- 2380 C5
- 2385 C5
- 2390 C5
- 2395 C5
- 2300 C6
- 2305 C6
- 2310 C6
- 2315 C6
- 2320 C6
- 2325 C6
- 2330 C6
- 2335 C6
- 2340 C6
- 2345 C6
- 2350 C6
- 2355 C6
- 2360 C6
- 2365 C6
- 2370 C6
- 2375 C6
- 2380 C6
- 2385 C6
- 2390 C6
- 2395 C6
- 2300 C7
- 2305 C7
- 2310 C7
- 2315 C7
- 2320 C7
- 2325 C7
- 2330 C7
- 2335 C7
- 2340 C7
- 2345 C7
- 2350 C7
- 2355 C7
- 2360 C7
- 2365 C7
- 2370 C7
- 2375 C7
- 2380 C7
- 2385 C7
- 2390 C7
- 2395 C7
- 2300 C8
- 2305 C8
- 2310 C8
- 2315 C8
- 2320 C8
- 2325 C8
- 2330 C8
- 2335 C8
- 2340 C8
- 2345 C8
- 2350 C8
- 2355 C8
- 2360 C8
- 2365 C8
- 2370 C8
- 2375 C8
- 2380 C8
- 2385 C8
- 2390 C8
- 2395 C8
- 2300 C9
- 2305 C9
- 2310 C9
- 2315 C9
- 2320 C9
- 2325 C9
- 2330 C9
- 2335 C9
- 2340 C9
- 2345 C9
- 2350 C9
- 2355 C9
- 2360 C9
- 2365 C9
- 2370 C9
- 2375 C9
- 2380 C9
- 2385 C9
- 2390 C9
- 2395 C9
- 2300 D1
- 2305 D1
- 2310 D1
- 2315 D1
- 2320 D1
- 2325 D1
- 2330 D1
- 2335 D1
- 2340 D1
- 2345 D1
- 2350 D1
- 2355 D1
- 2360 D1
- 2365 D1
- 2370 D1
- 2375 D1
- 2380 D1
- 2385 D1
- 2390 D1
- 2395 D1
- 2300 D2
- 2305 D2
- 2310 D2
- 2315 D2
- 2320 D2
- 2325 D2
- 2330 D2
- 2335 D2
- 2340 D2
- 2345 D2
- 2350 D2
- 2355 D2
- 2360 D2
- 2365 D2
- 2370 D2
- 2375 D2
- 2380 D2
- 2385 D2
- 2390 D2
- 2395 D2
- 2300 D3
- 2305 D3
- 2310 D3
- 2315 D3
- 2320 D3
- 2325 D3
- 2330 D3
- 2335 D3
- 2340 D3
- 2345 D3
- 2350 D3
- 2355 D3
- 2360 D3
- 2365 D3
- 2370 D3
- 2375 D3
- 2380 D3
- 2385 D3
- 2390 D3
- 2395 D3
- 2300 D4
- 2305 D4
- 2310 D4
- 2315 D4
- 2320 D4
- 2325 D4
- 2330 D4
- 2335 D4
- 2340 D4
- 2345 D4
- 2350 D4
- 2355 D4
- 2360 D4
- 2365 D4
- 2370 D4
- 2375 D4
- 2380 D4
- 2385 D4
- 2390 D4
- 2395 D4
- 2300 D5
- 2305 D5
- 2310 D5
- 2315 D5
- 2320 D5
- 2325 D5
- 2330 D5
- 2335 D5
- 2340 D5
- 2345 D5
- 2350 D5
- 2355 D5
- 2360 D5
- 2365 D5
- 2370 D5
- 2375 D5
- 2380 D5
- 2385 D5
- 2390 D5
- 2395 D5
- 2300 D6
- 2305 D6
- 2310 D6
- 2315 D6
- 2320 D6
- 2325 D6
- 2330 D6
- 2335 D6
- 2340 D6
- 2345 D6
- 2350 D6
- 2355 D6
- 2360 D6
- 2365 D6
- 2370 D6
- 2375 D6
- 2380 D6
- 2385 D6
- 2390 D6
- 2395 D6
- 2300 D7
- 2305 D7
- 2310 D7
- 2315 D7
- 2320 D7
- 2325 D7
- 2330 D7
- 2335 D7
- 2340 D7
- 2345 D7
- 2350 D7
- 2355 D7
- 2360 D7
- 2365 D7
- 2370 D7
- 2375 D7
- 2380 D7
- 2385 D7
- 2390 D7
- 2395 D7
- 2300 D8
- 2305 D8
- 2310 D8
- 2315 D8
- 2320 D8
- 2325 D8
- 2330 D8
- 2335 D8
- 2340 D8
- 2345 D8
- 2350 D8
- 2355 D8
- 2360 D8
- 2365 D8
- 2370 D8
- 2375 D8
- 2380 D8
- 2385 D8
- 2390 D8
- 2395 D8
- 2300 D9
- 2305 D9
- 2310 D9
- 2315 D9
- 2320 D9
- 2325 D9
- 2330 D9
- 2335 D9
- 2340 D9
- 2345 D9
- 2350 D9
- 2355 D9
- 2360 D9
- 2365 D9
- 2370 D9
- 2375 D9
- 2380 D9
- 2385 D9
- 2390 D9
- 2395 D9
- 2300 D10
- 2305 D10
- 2310 D10
- 2315 D10
- 2320 D10
- 2325 D10
- 2330 D10
- 2335 D10
- 2340 D10
- 2345 D10
- 2350 D10
- 2355 D10
- 2360 D10
- 2365 D10
- 2370 D10
- 2375 D10
- 2380 D10
- 2385 D10
- 2390 D10
- 2395 D10

AUDIO PART

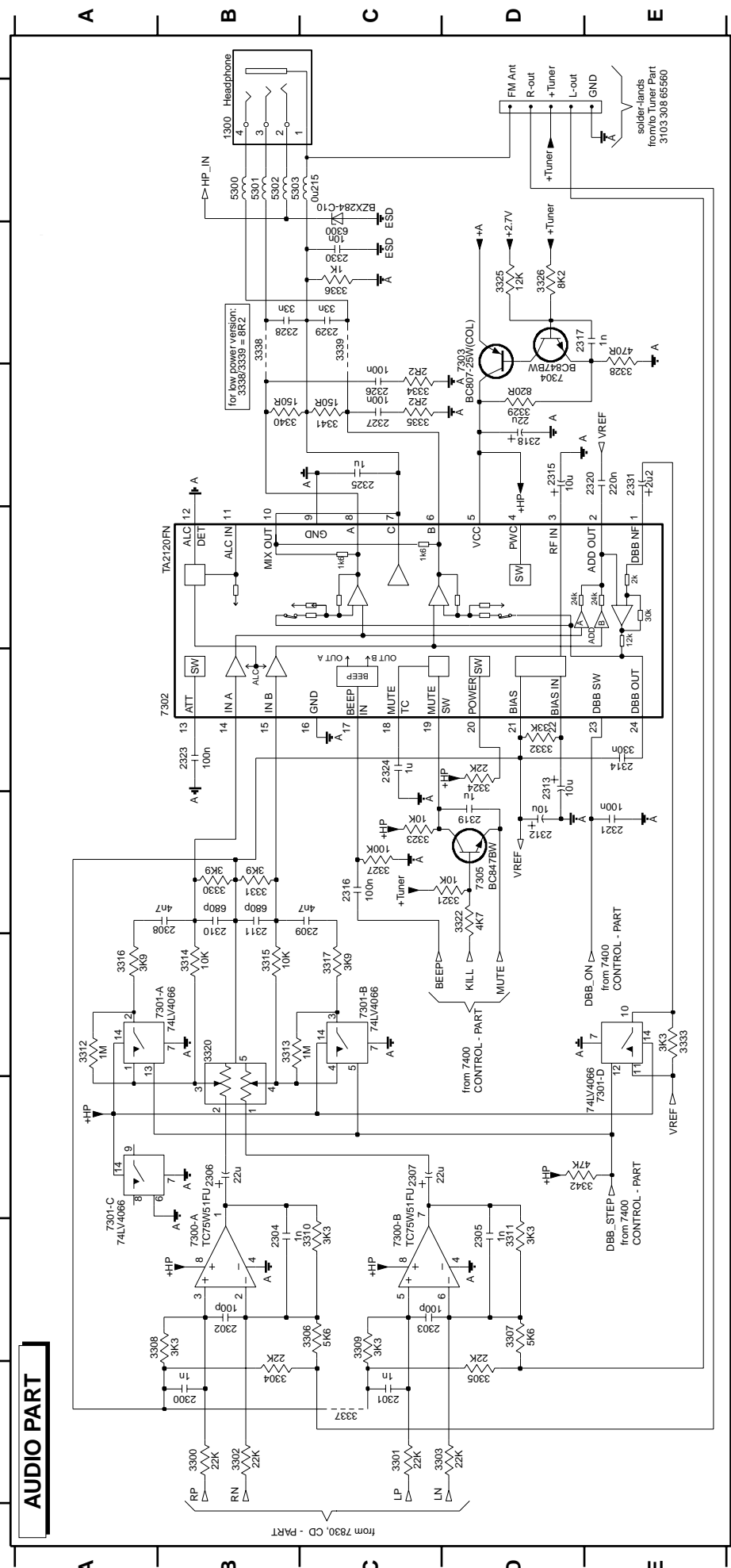

- 1250 I5
- 1252 D9
- 1300 H1
- 1401 B2
- 1404 F1
- 1831 E2
- 2212 I5
- 2214 H5
- 2215 H5
- 2219 G5
- 2230 D9
- 2251 H6
- 2269 B8
- 2270 B8
- 2306 H3
- 2307 H2
- 2312 H3
- 2313 I3
- 2315 H4
- 2318 I4
- 2330 G2
- 2331 H3
- 2408 C6
- 2803 B3
- 2804 B2
- 2830 E1
- 2833 D2
- 2835 D1
- 2843 C2
- 2864 B3
- 2883 G2
- 2884 G3
- 2885 F2
- 2886 G1
- 2887 G3
- 3211 G5
- 3212 G5
- 3230 B8
- 3231 B8
- 3247 B7
- 3249 D8
- 3250 D8
- 3251 D8
- 3253 E8
- 3257 G5
- 3258 H5
- 3259 H5
- 3298 B8
- 3299 A7
- 3320 J2
- 3402 C7
- 3403 C7
- 3412 F1
- 3413 F1
- 3429 A7
- 3806 B3
- 3830 F2
- 3837 D2
- 3839 D1
- 3842 D1
- 3844 D2
- 3847 C2
- 3853 F2
- 3890 F2
- 6232 C7
- 6257 C8
- 6258 B7
- 6300 G2
- 7230 B8
- 7251 G6
- 7261 B8
- 7262 B8
- 7881 F2

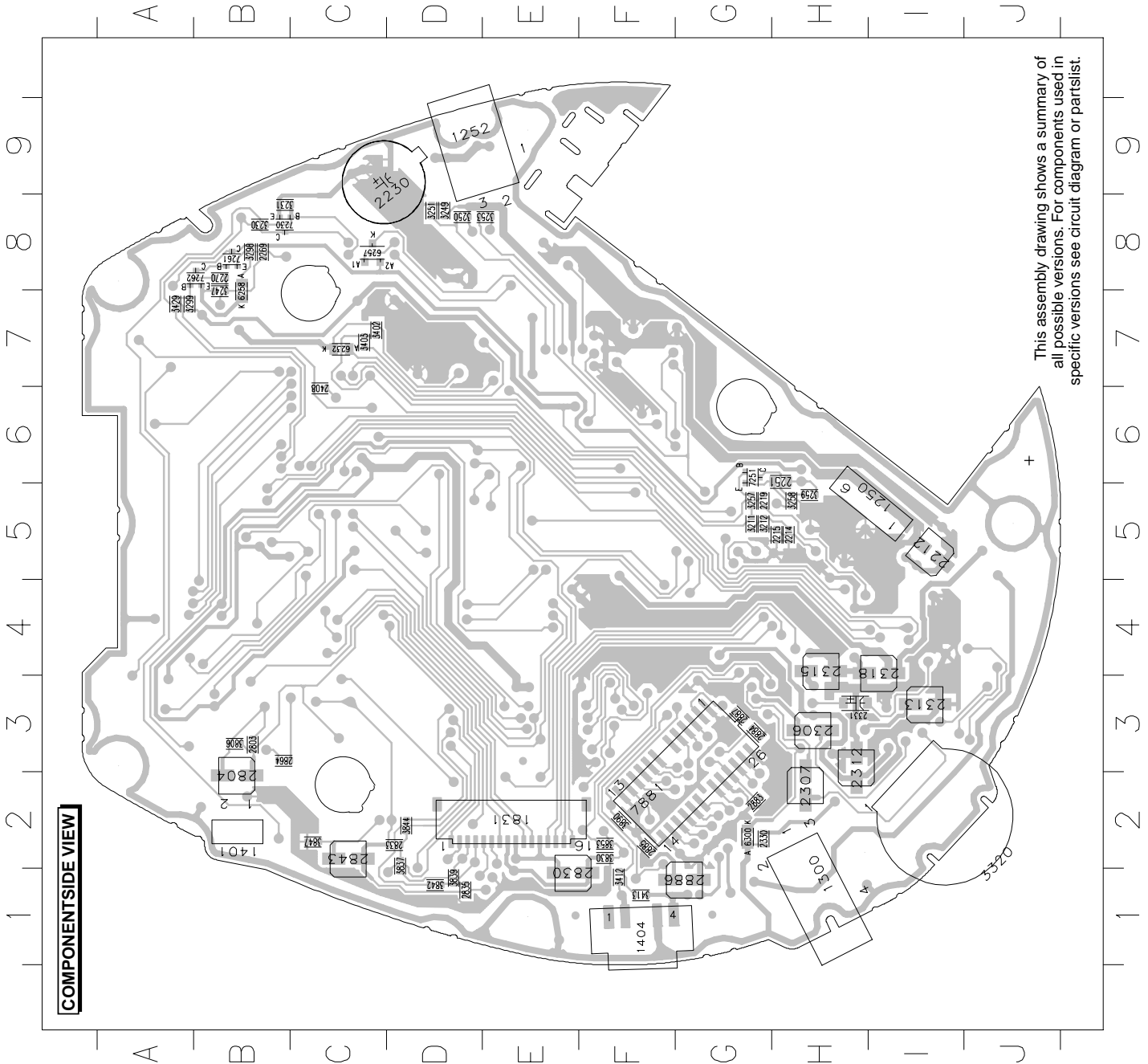



COPPERSIDE VIEW

This assembly drawing shows a summary of all possible versions. For components used in specific versions see circuit diagram or partslist.

1251 D1	2401 B3	3220 H6	3301 F5	3424 A7	5301 I8
1405 A5	2402 C3	3221 E4	3302 F6	3425 B7	5302 H8
2210 I6	2403 C3	3222 D1	3303 F5	3426 C6	5303 H8
2211 I5	2404 F5	3232 D1	3304 F6	3427 D5	5400 D3
2213 I5	2405 D4	3233 C1	3305 F5	3428 D5	5401 D4
2216 H5	2406 D4	3234 C2	3306 F6	3800 B6	5801 D6
2217 H5	2407 D4	3235 C1	3307 F5	3801 C6	6230 D1
2218 H6	2409 D5	3236 C2	3308 F6	3802 C6	6231 D1
2220 E4	2410 D5	3237 B2	3309 F5	3803 C7	6233 B3
2221 H6	2411 D5	3238 C2	3310 F6	3804 B8	6250 D2
2222 H6	2412 C5	3239 B2	3311 F5	3805 C7	6251 D2
2223 H6	2413 C5	3240 B2	3312 J7	3807 C7	6252 E2
2224 G5	2414 C5	3241 B2	3313 J6	3809 C6	6253 C2
2225 G5	2415 A7	3242 B3	3314 I8	3810 C7	6254 E2
2231 C2	2800 B7	3243 B3	3315 I8	3831 B7	6255 C2
2232 B2	2801 C6	3244 C2	3316 I7	3832 B8	6256 E4
2250 D1	2802 B7	3245 B2	3317 J7	3833 B8	6259 E3
2252 G4	2805 C7	3252 E2	3321 B5	3834 B8	6400 A3
2253 F4	2831 C6	3254 E3	3322 B5	3835 D6	7111 G6
2254 F4	2832 C7	3255 E3	3323 I6	3836 C6	7210 H5
2255 F3	2834 D8	3256 F3	3324 I6	3838 D8	7212 E4
2256 C2	2836 D9	3260 G4	3325 I6	3840 D9	7231 C2
2257 D2	2837 D7	3261 G5	3326 I5	3841 D9	7232 C1
2258 D3	2838 D7	3262 G5	3327 I7	3843 D9	7233 B2
2259 E4	2839 D7	3263 G4	3328 I6	3845 C7	7234 B2
2260 E3	2840 D7	3264 F4	3329 I5	3846 C6	7235 B2
2261 F4	2841 D7	3265 G4	3330 I7	3848 D7	7236 B2
2262 E3	2842 D7	3266 F4	3331 I8	3849 C8	7250 E3
2263 E3	2844 D7	3267 G5	3332 I7	3850 D8	7252 E4
2264 E2	2845 D7	3268 G5	3333 I6	3851 D8	7253 F3
2265 E2	2846 C8	3269 F5	3334 H8	3852 E8	7254 F3
2266 F3	2847 D8	3270 F4	3335 H7	3854 E8	7255 F3
2267 E3	2848 D8	3271 F4	3336 H7	3855 E8	7256 G3
2268 E4	2849 D7	3272 F3	3337 F6	3856 E8	7257 G4
2271 D1	2850 E8	3273 F3	3338 H8	3857 E9	7258 D2
2300 F6	2851 E8	3274 E2	3339 H7	3858 E8	7259 E3
2301 F5	2852 E8	3275 F3	3340 H6	3859 E8	7260 D3
2302 F6	2853 E8	3276 F3	3341 H6	3860 E8	7300 F5
2303 F5	2854 F8	3277 F3	3342 J6	3861 F8	7301 I6
2304 F6	2855 E8	3278 F3	3400 C3	3862 F8	7302 H7
2305 F5	2856 F8	3279 G3	3401 C3	3863 D6	7303 I5
2308 I7	2857 D6	3280 F3	3404 B6	3865 E6	7304 I5
2309 J7	2858 D6	3281 G3	3405 B6	3866 C7	7305 B5
2310 I8	2859 E6	3282 G3	3406 B6	3867 D6	7400 C4
2311 I8	2860 E6	3283 G4	3407 B6	3868 D6	7401 B6
2314 I8	2861 D6	3284 C6	3408 B6	3869 E6	7402 C6
2316 I7	2862 E8	3285 C2	3409 B5	3870 E6	7403 A7
2317 I5	2863 F8	3286 C2	3410 B6	3880 G8	7404 C5
2319 C5	2880 F8	3287 C2	3411 D3	3881 F8	7400 C7
2320 H7	2881 F8	3288 E4	3414 C5	3882 F8	7801 B6
2321 I6	2882 G7	3289 E4	3415 D5	3883 F8	7830 E7
2323 I7	2889 F7	3290 E4	3416 C5	3885 F8	7880 F7
2324 I7	3213 G5	3291 E3	3417 A3	3886 F7	7882 F6
2325 H7	3214 H5	3292 F4	3418 B7	3887 F6	7883 D2
2326 H8	3215 G6	3293 D3	3419 B7	3888 G6	
2327 H7	3216 G6	3294 F3	3420 A3	3902 C7	
2328 H8	3217 G5	3295 F3	3421 C5	5250 D2	
2329 H8	3218 G6	3297 F3	3422 C5	5251 E3	
2400 C3	3219 G5	3300 F6	3423 C5	5300 H8	

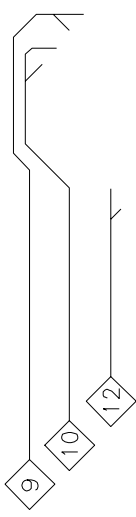
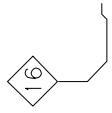
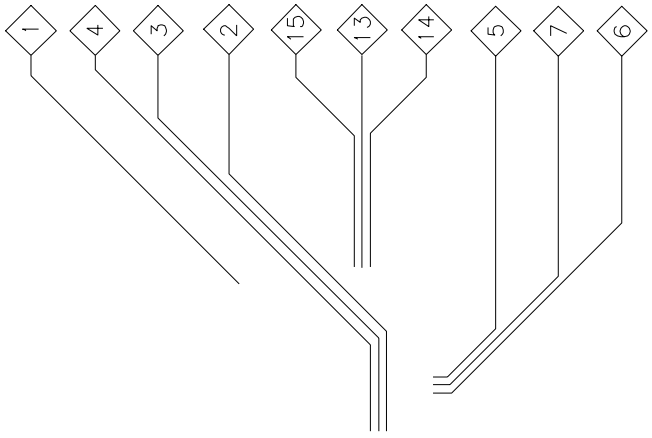

◇ For service testpoints see
blockdiagram or circuit diagram

+

TUNER BOARD

The tuner is not intended to be repaired on component level.
 An adjusted printed board assembly is available with codenumber 3103 308 65050.
 Circuit diagram and printed board is published for orientation only.

- 1005 B4
- 1006 B6
- 1008 C4
- 1008 C4
- 1009 D4
- 1100 A5
- 2061 A2
- 2062 B3
- 2064 C3
- 2064 C3
- 2065 D1
- 2066 C1
- 2067 B3
- 2068 B2
- 2069 B3
- 2071 C6
- 2071 C6
- 2072 D2
- 2073 C2
- 2074 B4
- 2075 C5
- 2076 B4
- 2077 B4
- 2078 C2
- 2079 B5
- 2081 B4
- 2082 B5
- 2083 C3
- 2084 C3
- 2085 B3
- 2086 B4
- 2087 B4
- 2088 B4
- 2089 B6
- 2091 B6
- 2092 C4
- 2093 C4
- 2094 C5
- 2095 C4
- 2097 C4
- 2098 B5
- 2099 C3
- 2100 C5
- 2101 C4
- 2102 D3
- 2103 D3
- 2104 D4
- 2105 D3
- 2106 D3
- 2107 D3
- 2108 D7
- 2110 D6
- 2111 D3
- 2111 D3
- 2112 D3
- 2113 D6
- 2114 D6
- 2115 D7
- 2116 D6
- 2117 D6
- 2118 D6
- 2119 D6
- 2120 C7
- 2121 C7
- 2123 D4
- 2124 D4
- 2125 B4
- 2126 B4
- 2127 B2
- 2128 C5
- 2129 C5
- 2131 B3
- 2132 C7
- 2133 D7
- 2134 C7
- 2135 C7
- 3047 C6
- 3048 C3
- 3049 A2
- 3051 C2
- 3053 C2
- 3054 C6
- 3055 A6
- 3058 A6
- 3059 C5
- 3060 A4
- 3061 B6
- 3062 C2
- 3064 B6
- 3066 C2
- 3066 A6
- 3068 C4
- 3068 C4
- 3071 C4
- 3084 D4
- 3085 D7
- 3086 D5
- 3087 D7
- 3075 D4
- 3076 A2
- 3078 D4
- 3079 D5
- 3080 D3
- 3081 D7
- 3082 D7
- 3084 D4
- 3085 D7
- 3102 D1
- 3103 C4
- 3074 B4
- 3087 D7
- 3089 D4
- 3090 D5
- 3092 B5
- 3093 B5
- 3094 B3
- 3095 C5
- 3096 B6
- 3099 C7
- 3101 C7
- 3102 D1
- 3103 C4
- 3103 C4
- 3103 C4
- 4050 C6
- 4051 A6
- 5002 C3
- 6008 B3
- 6009 C2
- 6010 B2
- 6011 D2
- 7022 B4
- 7023 D7
- 7024 D7
- 7025 D5
- 7026 C7
- 7027 D5
- 7028 D5
- 7029 C5
- 7030 C7

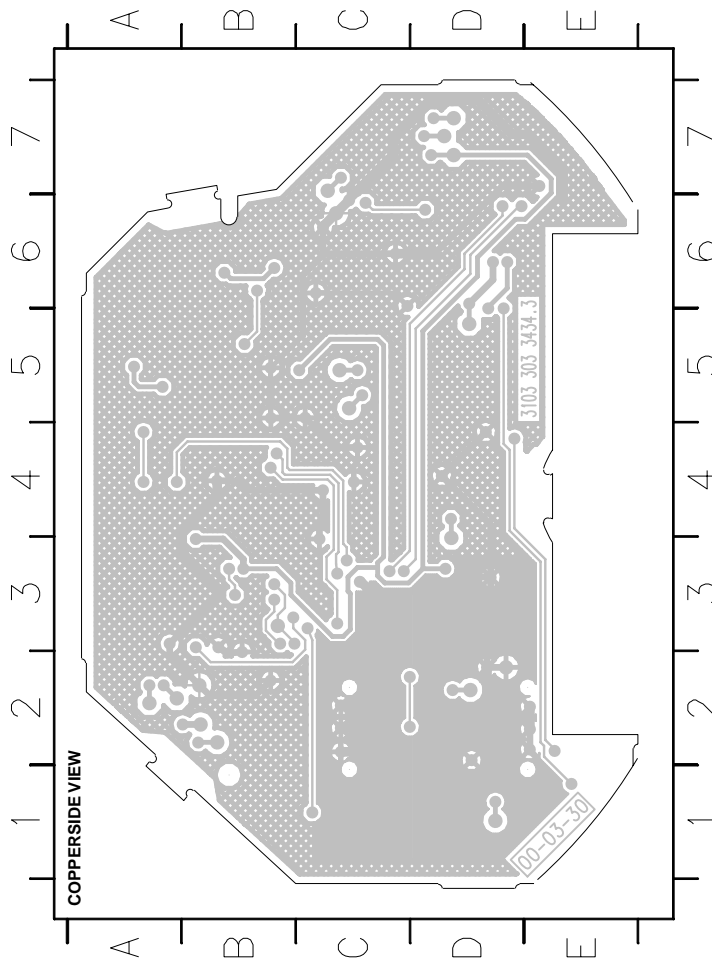
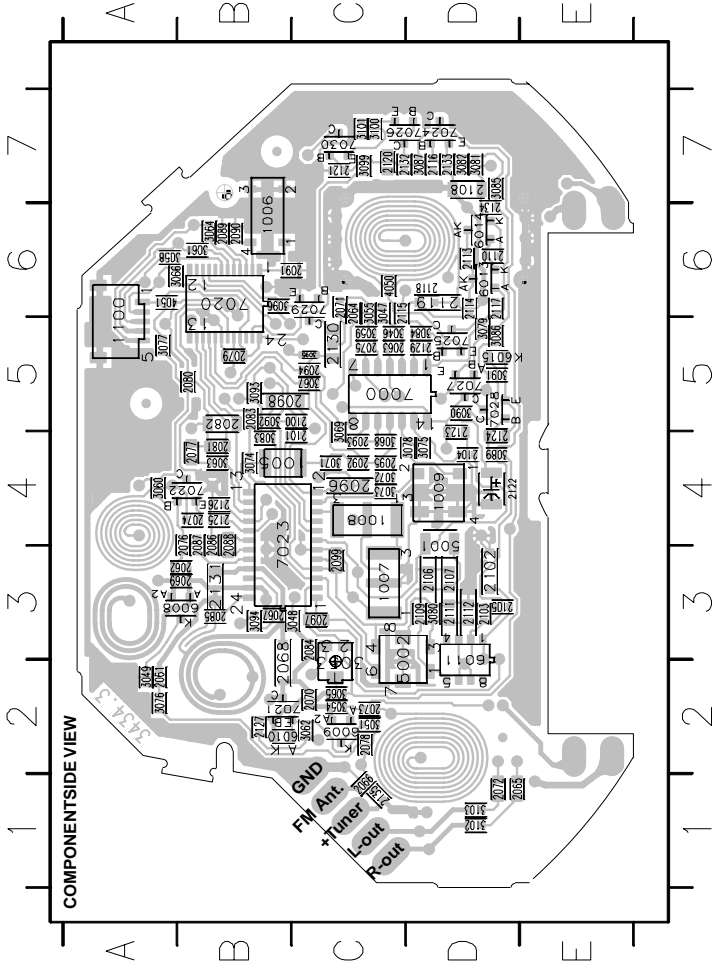

EXPLODED VIEW

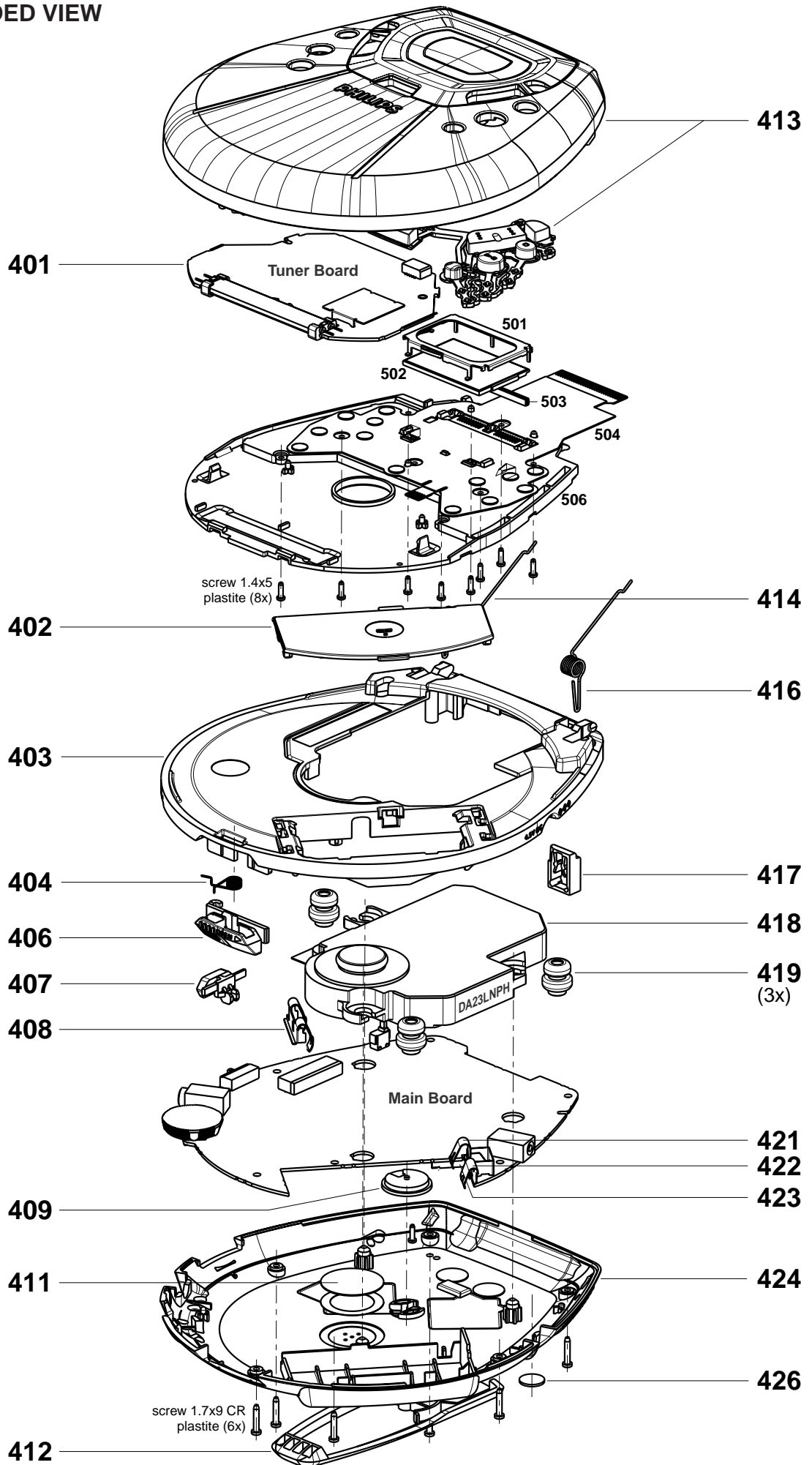

MECHANICAL PARTSLIST

401	3103 308 65050	TUNER BOARD ASSEMBLY
402	3103 304 70320	DOOR-BATTERY-2
403	3103 307 99710	CABINET-ASSY-2
404	3103 301 06500	SPRING-SLIDER-OPEN-2
406	3103 304 69580	SLIDER-OPEN
407	3103 304 69570	SLIDER-RESUME
408	3103 301 45180	SPRING-BATTERY-SHORT-2
409	3103 304 69540	COVER-BOTTOM
411	2422 527 01003	BUZZER PIEZO
412	3103 304 70250	BELT CLIP
413	3103 308 11340	DOOR-CD-T-ASSY-1
414	3103 301 06620	SPRING-OPEN-LEFT-T
416	3103 301 06630	SPRING-OPEN-RIGHT-T
417	3103 304 69560	BRAKE
418	3103 309 05320	CD-DRIVE DA23LNPH
419	3103 304 69590	SUSPENSION
421	3103 301 45410	SPRING-BATTERY-MINUS
422	3103 301 45420	SPRING-BATTERY-PLUS
423	3103 301 45430	SPRING-BATTERY-CHARGE
424	3103 307 99900	BOTTOM-T-ASSY-1 (not for /17)
424	3103 307 99940	BOTTOM-T-ASSY-2 (only for /17)
426	4822 462 41819	RUBBER FOOT
	4822 502 13872	SCREW 1.4x5 PLASTITE
	3103 300 41580	SCREW 1.7x9 CR PLASTITE

ELECTRICAL PARTSLIST

MISCELLANEOUS

402	3103 308 84140	LCD-DORIS-2T
1250	2422 025 12272	CONNECTOR, CD-DRIVE (6 pins)
1251 ▲	2422 086 11012	FUSE ICP-S0.7 (700mA 50V UL)
1252	2422 026 05086	EXT.DC-JACK
1300	4822 265 11565	SOCKET, HEADPHONE/RC HSJ1637
1401	4822 276 12889	SWITCH (CD-DOOR)
1404	4822 277 21705	SWITCH, SLIDE (HOLD/RESUME)
1405	2422 025 16853	CONNECTOR, FLEX-FOIL (28 pins)
1831	4822 267 11027	CONNECTOR, CD-DRIVE (16 pins)

CAPACITORS

2210◎	4822 126 14305	100nF	10%	16V
2211◎	4822 126 14305	100nF	10%	16V
2212◎	4822 124 23237	22µF	20%	6,3V
2213◎	4822 126 14043	1µF	20%	16V
2214◎	4822 126 14305	100nF	10%	16V
2215◎	5322 126 11583	10nF	10%	63V
2216◎	4822 126 13883	220pF	5%	50V
2217◎	4822 126 13883	220pF	5%	50V
2218◎	4822 126 14305	100nF	10%	16V
2219◎	5322 126 11583	10nF	10%	63V
2220◎	4822 122 31765	100pF	5%	50V
2221◎	3198 017 41050	1µF	20%	10V
2222◎	4822 126 14043	1µF	20%	16V
2223◎	4822 126 13883	220pF	5%	50V
2224◎	4822 126 13883	220pF	5%	50V
2225◎	4822 126 14305	100nF	10%	16V
2230◎	2020 025 90023	100mF	20%	5,5V
2231◎	4822 126 14305	100nF	10%	16V
2232◎	4822 122 31765	100pF	5%	50V
2250◎	4822 126 14305	100nF	10%	16V
2251◎	4822 126 14472	1µF	10%	10V
2252◎	4822 126 13881	470pF	5%	50V
2253◎	5322 126 11578	1nF	10%	63V
2254◎	4822 126 14305	100nF	10%	16V
2255◎	4822 122 31765	100pF	5%	50V
2256◎	4822 126 14472	1µF	10%	10V
2257◎	2020 552 96305	4,7µF	20%	10V
2258◎	4822 126 14472	1µF	10%	10V
2259◎	4822 122 33741	10pF	10%	50V
2260◎	5322 126 11579	3,3nF	10%	63V
2261◎	4822 126 14305	100nF	10%	16V
2262◎	5322 126 11583	10nF	10%	63V
2263◎	4822 122 33777	47pF	5%	63V
2264◎	4822 126 14472	1µF	10%	10V
2265◎	2022 009 00656	47µF	20%	6,3V
2266◎	4822 124 11946	22µF	20%	16V
2267◎	5322 126 11583	10nF	10%	63V
2268◎	4822 122 31765	100pF	5%	50V
2269◎	3198 017 41050	1µF	20%	10V
2270◎	4822 126 14305	100nF	10%	16V
2271◎	3198 017 41050	1µF	20%	10V
2300◎	5322 126 11578	1nF	10%	63V
2301◎	5322 126 11578	1nF	10%	63V
2302◎	4822 122 31765	100pF	5%	50V
2303◎	4822 122 31765	100pF	5%	50V
2304◎	5322 126 11578	1nF	10%	63V
2305◎	5322 126 11578	1nF	10%	63V
2306◎	4822 124 23237	22µF	20%	6,3V
2307◎	4822 124 23237	22µF	20%	6,3V
2308◎	4822 126 13193	4,7nF	10%	63V

CAPACITORS

2309◎	4822 126 13193	4,7nF	10%	63V
2310◎	4822 126 13909	680pF	10%	50V
2311◎	4822 126 13909	680pF	10%	50V
2312◎	4822 124 23002	10µF	20%	16V
2313◎	4822 124 23002	10µF	20%	16V
2314◎	2020 552 96327	330nF	10%	16V
2315◎	4822 124 23002	10µF	20%	16V
2316◎	4822 126 14305	100nF	10%	16V
2317◎	5322 126 11578	1nF	10%	63V
2318◎	4822 124 23237	22µF	20%	6,3V
2319◎	4822 126 14043	1µF	20%	16V
2320◎	4822 126 13879	220nF	20%	16V
2321◎	4822 126 14305	100nF	10%	16V
2323◎	4822 126 14305	100nF	10%	16V
2324◎	4822 126 14472	1µF	10%	10V
2325◎	4822 126 14472	1µF	10%	10V
2326◎	4822 126 14305	100nF	10%	16V
2327◎	4822 126 14305	100nF	10%	16V
2328◎	4822 126 14549	33nF	10%	16V
2329◎	4822 126 14549	33nF	10%	16V
2330◎	5322 126 11583	10nF	10%	63V
2331◎	4822 123 14018	2,2µF	10%	10V
2400◎	4822 126 14305	100nF	10%	16V
2401◎	4822 126 14305	100nF	10%	16V
2402◎	4822 126 14494	22nF	10%	25V
2403◎	4822 126 14305	100nF	10%	16V
2404◎	3198 017 41050	1µF	20%	10V
2405◎	2020 552 96305	4,7µF	20%	10V
2406◎	4822 122 33761	22pF	5%	50V
2407◎	4822 122 33761	22pF	5%	50V
2408◎	4822 126 13879	220nF	20%	16V
2409◎	5322 126 11578	1nF	10%	63V
2410◎	5322 126 11578	1nF	10%	63V
2411◎	5322 126 11578	1nF	10%	63V
2412◎	5322 126 11578	1nF	10%	63V
2413◎	4822 126 14043	1µF	20%	16V
2414◎	4822 126 14305	100nF	10%	16V
2415◎	4822 126 14305	100nF	10%	16V
2800◎	4822 126 14083	4,7µF	20%	10V
2801◎	4822 126 13193	4,7nF	10%	63V
2802◎	4822 126 14083	4,7µF	20%	10V
2803◎	4822 126 14305	100nF	10%	16V
2804◎	4822 124 81058	47µF	20%	4V
2805◎	3198 016 34780	4,7pF	5%	50V
2830◎	4822 124 23237	22µF	20%	6,3V
2831◎	4822 126 14508	180pF	5%	50V
2832◎	4822 126 14241	330pF		50V
2833◎	4822 126 14508	180pF	5%	50V
2834◎	4822 126 14508	180pF	5%	50V
2835◎	4822 126 14508	180pF	5%	50V
2836◎	4822 126 14508	180pF	5%	50V
2837◎	4822 126 13883	220pF	5%	50V
2838◎	4822 126 13883	220pF	5%	50V
2839◎	4822 126 13883	220pF	5%	50V
2840◎	4822 126 13883	220pF	5%	50V
2841◎	4822 126 13883	220pF	5%	50V
2842◎	4822 126 13883	220pF	5%	50V
2843◎	4822 124 23237	22µF	20%	6,3V
2844◎	4822 126 14305	100nF	10%	16V
2845◎	3198 017 34730	47nF	10%	16V X7R
2846◎	5322 126 11578	1nF	10%	63V
2847◎	4822 126 14494	22nF	10%	25V
2848◎	4822 126 11669	27pF	10%	50V
2849◎	5322 126 11583	10nF	10%	63V

CAPACITORS

2850	©	5322 126 11579	3,3nF	10%	63V
2851	©	5322 126 11579	3,3nF	10%	63V
2852	©	5322 126 11579	3,3nF	10%	63V
2853	©	5322 126 11579	3,3nF	10%	63V
2854	©	4822 126 14247	1,5nF	10%	50V
2855	©	4822 126 14247	1,5nF	10%	50V
2856	©	4822 126 14549	33nF	10%	16V
2857	©	4822 126 14305	100nF	10%	16V
2858	©	4822 126 13344	1,5nF	5%	63V
2859	©	2022 009 00656	47µF	20%	6,3V
2860	©	4822 126 13344	1,5nF	5%	63V
2861	©	3198 017 41050	1µF	20%	10V
2862	©	3198 017 41050	1µF	20%	10V
2863	©	3198 017 41050	1µF	20%	10V
2864	©	4822 126 14305	100nF	10%	16V
2880	©	4822 126 14305	100nF	10%	16V
2881	©	4822 126 14305	100nF	10%	16V
2882	©	4822 126 14305	100nF	10%	16V
2883	©	4822 122 31765	100pF	5%	50V
2884	©	4822 122 33777	47pF	5%	63V
2885	©	4822 126 14549	33nF	10%	16V
2886	©	4822 124 23237	22µF	20%	6,3V
2887	©	4822 126 14549	33nF	10%	16V
2889	©	3198 016 31590	15pF	5%	50V

RESISTORS

3211	©	4822 051 30562	5,6kΩ	5%	0,06W
3212	©	4822 051 30103	10kΩ	5%	0,06W
3213	©	4822 051 30184	180kΩ	5%	0,06W
3218	©	4822 117 12925	47kΩ	1%	0,06W
3219	©	4822 117 12925	47kΩ	1%	0,06W
3220	©	4822 117 13632	100kΩ	1%	0,06W
3221	©	4822 051 30563	56kΩ	5%	0,06W
3222	©	4822 051 30102	1kΩ	5%	0,06W
3230	©	4822 051 30105	1MΩ	5%	0,06W
3231	©	4822 051 30105	1MΩ	5%	0,06W
3232	©	4822 051 30103	10kΩ	5%	0,06W
3233	©	4822 051 30331	330Ω	5%	0,06W
3234	©	4822 117 12891	220kΩ	1%	0,06W
3235	©	4822 117 13632	100kΩ	1%	0,06W
3236	©	4822 051 30105	1MΩ	5%	0,06W
3237	©	4822 051 30154	150kΩ	5%	0,06W
3238	©	4822 117 12864	82kΩ	5%	0,6W
3239	©	4822 051 30105	1MΩ	5%	0,06W
3240	©	4822 051 30105	1MΩ	5%	0,06W
3241	©	3198 021 32250	2,2MΩ	5%	0,06W
3242	©	4822 051 30392	3,9kΩ	5%	0,06W
3243	©	4822 051 30222	2,2kΩ	5%	0,06W
3244	©	3198 021 32250	2,2MΩ	5%	0,06W
3245	©	4822 117 13632	100kΩ	1%	0,06W
3247	©	4822 051 30102	1kΩ	5%	0,06W
3249	©	4822 051 30103	10kΩ	5%	0,06W
3250	©	4822 051 30103	10kΩ	5%	0,06W
3251	©	4822 117 12925	47kΩ	1%	0,06W
3252	©	4822 117 13632	100kΩ	1%	0,06W
3253	©	4822 117 13632	100kΩ	1%	0,06W
3254	©	2120 108 93057	68kΩ	1%	0,06W
3255	©	2120 108 93057	68kΩ	1%	0,06W
3256	©	4822 051 30223	22kΩ	5%	0,06W
3257	©	4822 051 30103	10kΩ	5%	0,06W
3258	©	4822 051 30472	4,7kΩ	5%	0,06W
3259	©	4822 051 30183	18kΩ	5%	0,06W
3260	©	4822 051 30183	18kΩ	5%	0,06W
3261	©	4822 117 13632	100kΩ	1%	0,06W

RESISTORS

3262	©	4822 117 13632	100kΩ	1%	0,06W
3263	©	4822 051 30334	330kΩ	5%	0,06W
3264	©	4822 051 30223	22kΩ	5%	0,06W
3265	©	4822 051 30334	330kΩ	5%	0,06W
3266	©	4822 051 30103	10kΩ	5%	0,06W
3267	©	4822 117 12925	47kΩ	1%	0,06W
3268	©	4822 051 30562	5,6kΩ	5%	0,06W
3269	©	4822 051 30103	10kΩ	5%	0,06W
3270	©	4822 051 30103	10kΩ	5%	0,06W
3271	©	4822 051 30103	10kΩ	5%	0,06W
3272	©	4822 051 30561	560Ω	5%	0,06W
3273	©	4822 051 30103	10kΩ	5%	0,06W
3274	©	4822 117 12917	1Ω	5%	0,06W
3275	©	4822 117 12917	1Ω	5%	0,06W
3276	©	3198 021 32250	2,2MΩ	5%	0,06W
3277	©	4822 051 30474	470kΩ	5%	0,06W
3278	©	4822 051 30474	470kΩ	5%	0,06W
3279	©	4822 051 30474	470kΩ	5%	0,06W
3280	©	2120 108 93943	18kΩ	1%	0,06W
3281	©	4822 116 30467	10kΩ	5%	NTC
3282	©	4822 051 30103	10kΩ	5%	0,06W
3284	©	4822 117 13632	100kΩ	1%	0,06W
3285	©	4822 117 13632	100kΩ	1%	0,06W
3286	©	4822 051 30103	10kΩ	5%	0,06W
3287	©	4822 117 13632	100kΩ	1%	0,06W
3288	©	4822 117 13632	100kΩ	1%	0,06W
3289	©	4822 051 30103	10kΩ	5%	0,06W
3290	©	4822 051 30474	470kΩ	5%	0,06W
3291	©	4822 051 30222	2,2kΩ	5%	0,06W
3292	©	4822 051 30103	10kΩ	5%	0,06W
3294	©	4822 051 30681	680Ω	5%	0,06W
3295	©	4822 051 30103	10kΩ	5%	0,06W
3297	©	4822 117 12902	8,2kΩ	1%	0,06W
3298	©	4822 117 12903	1,8kΩ	1%	0,06W
3299	©	4822 051 30223	22kΩ	5%	0,06W
3300	©	4822 051 30223	22kΩ	5%	0,06W
3301	©	4822 051 30223	22kΩ	5%	0,06W
3302	©	4822 051 30223	22kΩ	5%	0,06W
3303	©	4822 051 30223	22kΩ	5%	0,06W
3304	©	4822 051 30223	22kΩ	5%	0,06W
3305	©	4822 051 30223	22kΩ	5%	0,06W
3306	©	4822 051 30562	5,6kΩ	5%	0,06W
3307	©	4822 051 30562	5,6kΩ	5%	0,06W
3308	©	4822 051 30332	3,3kΩ	5%	0,06W
3309	©	4822 051 30332	3,3kΩ	5%	0,06W
3310	©	4822 051 30332	3,3kΩ	5%	0,06W
3311	©	4822 051 30332	3,3kΩ	5%	0,06W
3312	©	4822 051 30105	1MΩ	5%	0,06W
3313	©	4822 051 30105	1MΩ	5%	0,06W
3314	©	4822 051 30103	10kΩ	5%	0,06W
3315	©	4822 051 30103	10kΩ	5%	0,06W
3316	©	4822 051 30392	3,9kΩ	5%	0,06W
3317	©	4822 051 30392	3,9kΩ	5%	0,06W
3320		3103 308 53680	2x10kΩ		POTMETER (CX2)
3321	©	4822 051 30103	10kΩ	5%	0,06W
3322	©	4822 051 30472	4,7kΩ	5%	0,06W
3323	©	4822 051 30103	10kΩ	5%	0,06W
3324	©	4822 051 30223	22kΩ	5%	0,06W
3325	©	4822 051 30123	12kΩ	5%	0,06W
3326	©	4822 117 12902	8,2kΩ	1%	0,06W
3327	©	4822 117 13632	100kΩ	1%	0,06W
3328	©	4822 051 30471	470Ω	5%	0,06W
3329	©	4822 117 12968	820Ω	5%	0,06W
3330	©	4822 051 30392	3,9kΩ	5%	0,06W

RESISTORS

3331 ©	4822 051 30392	3,9kΩ	5%	0,06W
3332 ©	4822 051 30333	33kΩ	5%	0,06W
3333 ©	4822 051 30332	3,3kΩ	5%	0,06W
3334 ©	4822 117 13613	2,2Ω	5%	0,06W
3335 ©	4822 117 13613	2,2Ω	5%	0,06W
3336 ©	4822 051 30102	1kΩ	5%	0,06W
3337 ©	4822 051 30008	CHIP JUMPER 0603		
3338 ©	2322 702 81828	8,2Ω	5%	0,06W not for /17
3338 ©	4822 051 30008	CHIP JUMPER 0603		only for /17
3339 ©	2322 702 81828	8,2Ω	5%	0,06W not for /17
3339 ©	4822 051 30008	CHIP JUMPER 0603		only for /17
3340 ©	4822 051 30151	150Ω	5%	0,06W
3341 ©	4822 051 30151	150Ω	5%	0,06W
3342 ©	4822 117 12925	47kΩ	1%	0,06W
3400 ©	4822 051 30103	10kΩ	5%	0,06W
3401 ©	4822 117 13632	100kΩ	1%	0,06W
3402 ©	4822 051 30223	22kΩ	5%	0,06W
3403 ©	4822 117 13632	100kΩ	1%	0,06W
3404 ©	4822 051 30105	1MΩ	5%	0,06W
3405 ©	4822 051 30105	1MΩ	5%	0,06W
3406 ©	4822 051 30105	1MΩ	5%	0,06W
3407 ©	4822 051 30105	1MΩ	5%	0,06W
3408 ©	2120 108 93053	680kΩ	1%	0,06W
3409 ©	5322 117 13044	470kΩ	1%	0,06W
3410 ©	4822 117 13632	100kΩ	1%	0,06W
3411 ©	4822 051 30109	10Ω	5%	0,06W
3412 ©	2120 108 93943	18kΩ	1%	0,06W
3413 ©	4822 117 13632	100kΩ	1%	0,06W
3414 ©	2120 108 93942	10kΩ	1%	0,06W
3415 ©	2120 108 93944	22kΩ	1%	0,06W
3416 ©	4822 051 30109	10Ω	5%	0,06W
3417 ©	4822 051 30223	22kΩ	5%	0,06W
3418 ©	4822 051 30102	1kΩ	5%	0,06W
3419 ©	4822 117 12891	220kΩ	1%	0,06W
3420 ©	4822 051 30105	1MΩ	5%	0,06W
3421 ©	4822 051 30101	100Ω	5%	0,06W
3422 ©	4822 051 30103	10kΩ	5%	0,06W
3423 ©	4822 051 30103	10kΩ	5%	0,06W
3424 ©	4822 051 30101	100Ω	5%	0,06W
3425 ©	4822 051 30223	22kΩ	5%	0,06W
3426 ©	4822 051 30105	1MΩ	5%	0,06W
3427 ©	3198 021 32250	2,2MΩ	5%	0,06W
3428 ©	4822 117 12891	220kΩ	1%	0,06W
3429 ©	4822 051 30222	2,2kΩ	5%	0,06W
3800 ©	4822 117 13608	4,7Ω	5%	0,06W
3801 ©	4822 051 30153	15kΩ	5%	0,06W
3802 ©	4822 051 30683	68kΩ	5%	0,06W
3803 ©	4822 051 30332	3,3kΩ	5%	0,06W
3804 ©	4822 051 30479	47Ω	5%	0,06W
3805 ©	4822 051 30472	4,7kΩ	5%	0,06W
3806 ©	4822 051 30332	3,3kΩ	5%	0,06W
3807 ©	4822 051 30471	470Ω	5%	0,06W
3809 ©	4822 051 30563	56kΩ	5%	0,06W
3810 ©	4822 051 30472	4,7kΩ	5%	0,06W
3830 ©	4822 051 30109	10Ω	5%	0,06W
3831 ©	4822 051 30562	5,6kΩ	5%	0,06W
3832 ©	4822 051 30562	5,6kΩ	5%	0,06W
3833 ©	4822 051 30562	5,6kΩ	5%	0,06W
3834 ©	4822 051 30562	5,6kΩ	5%	0,06W
3835 ©	4822 051 30273	27kΩ	5%	0,06W
3836 ©	4822 051 30273	27kΩ	5%	0,06W
3837 ©	4822 051 30333	33kΩ	5%	0,06W
3838 ©	4822 051 30333	33kΩ	5%	0,06W
3839 ©	4822 051 30333	33kΩ	5%	0,06W

RESISTORS

3840 ©	4822 051 30333	33kΩ	5%	0,06W
3841 ©	4822 051 30103	10kΩ	5%	0,06W
3842 ©	4822 051 30103	10kΩ	5%	0,06W
3843 ©	4822 051 30103	10kΩ	5%	0,06W
3844 ©	4822 051 30103	10kΩ	5%	0,06W
3845 ©	4822 051 30103	10kΩ	5%	0,06W
3846 ©	4822 051 30103	10kΩ	5%	0,06W
3847 ©	4822 051 30339	33Ω	5%	0,06W
3848 ©	4822 051 30333	33kΩ	5%	0,06W
3849 ©	4822 051 30102	1kΩ	5%	0,06W
3850 ©	4822 051 30223	22kΩ	5%	0,06W
3851 ©	4822 051 30102	1kΩ	5%	0,06W
3852 ©	4822 051 30109	10Ω	5%	0,06W
3853 ©	4822 051 30109	10Ω	5%	0,06W
3854 ©	4822 051 30222	2,2kΩ	5%	0,06W
3855 ©	4822 051 30222	2,2kΩ	5%	0,06W
3856 ©	4822 051 30222	2,2kΩ	5%	0,06W
3857 ©	4822 051 30222	2,2kΩ	5%	0,06W
3858 ©	4822 051 30222	2,2kΩ	5%	0,06W
3859 ©	4822 051 30222	2,2kΩ	5%	0,06W
3860 ©	4822 051 30103	10kΩ	5%	0,06W
3861 ©	4822 051 30103	10kΩ	5%	0,06W
3862 ©	4822 051 30103	10kΩ	5%	0,06W
3865 ©	4822 051 30332	3,3kΩ	5%	0,06W
3866 ©	4822 051 30105	1MΩ	5%	0,06W
3867 ©	4822 117 12139	22Ω	5%	0,06W
3868 ©	4822 117 12139	22Ω	5%	0,06W
3869 ©	4822 117 13608	4,7Ω	5%	0,06W
3870 ©	4822 051 30331	330Ω	5%	0,06W
3880 ©	4822 117 12139	22Ω	5%	0,06W
3885 ©	4822 051 30103	10kΩ	5%	0,06W
3886 ©	4822 051 30103	10kΩ	5%	0,06W
3887 ©	4822 117 12139	22Ω	5%	0,06W
3888 ©	4822 051 30103	10kΩ	5%	0,06W
3890 ©	4822 117 12139	22Ω	5%	0,06W
3902 ©	4822 117 12891	220kΩ	1%	0,06W

COILS

5250 ©	4822 157 11705	10μH	10%
5251 ©	2422 536 00058	2,2μH	20%
5300 ©	2422 535 91058	215nH	10%
5301 ©	2422 535 91058	215nH	10%
5302 ©	2422 535 91058	215nH	10%
5303 ©	2422 535 91058	215nH	10%
5400 ©	4822 242 10845	CER. RES. 4,23MHz	
5401 ©	4822 242 10971	DMX-26S (32,768kHz)	
5801 ©	8203 303 86080	CER. RES 33,86MHz	

DIODES

6230 ©	4822 130 11028	BZX284-C4V7	
6231 ©	9322 052 99685	BAT54WS	
6232 ©	9322 052 99685	BAT54WS	
6233 ©	4822 130 70064	LM285D	
6250 ©	4822 130 83757	BAS216	
6251 ©	9322 128 70685	SS14	
6252 ©	9322 128 70685	SS14	
6253 ©	4822 130 83757	BAS216	
6254 ©	4822 130 83757	BAS216	
6255 ©	4822 130 83757	BAS216	
6256 ©	4822 130 83757	BAS216	
6257 ©	4822 130 82594	BAT54C	
6258 ©	4822 130 83757	BAS216	
6259 ©	9322 052 99685	BAT54WS	
6300 ©	4822 130 10794	BZX284-C10	

DIODES

6400© 4822 130 82594 BAT54C

TRANSISTORS

7212© 3198 010 42310 BC847BW
 7230© 3198 010 42310 BC847BW
 7231© 3198 010 42310 BC847BW
 7232© 3198 010 42310 BC847BW
 7233© 5322 130 42756 BC857BW

7234© 3198 010 42310 BC847BW
 7235© 5322 130 42756 BC857BW
 7236© 3198 010 42310 BC847BW
 7251© 3198 010 42310 BC847BW
 7253© 3198 010 42310 BC847BW

7254© 5322 130 61569 BC868
 7255© 5322 130 42756 BC857BW
 7256© 3198 010 42310 BC847BW
 7258© 5322 130 42756 BC857BW
 7259© 5322 130 60123 BC807-40

7260© 4822 130 11549 BSH105
 7261© 3198 010 44350 BC807-25W
 7262© 3198 010 42310 BC847BW
 7303© 3198 010 44350 BC807-25W
 7304© 3198 010 42310 BC847BW

7305© 3198 010 42310 BC847BW
 7404© 5322 130 42756 BC857BW
 7801© 3198 010 42310 BC847BW
 7882© 3198 010 42310 BC847BW
 7883© 5322 130 42756 BC857BW

INTEGRATED CIRCUITS

7111© 9322 159 66685 TC75S51FU (Single OpAmp)
 7210© 9322 161 72668 MPC17A51ZVM (Servo Driver)
 7250© 4822 209 17289 74LV14PW (Hex Inverting Schmitt Trigger)
 7252© 9322 142 72685 TC75W51FU (Dual OpAmp)
 7257© 4822 209 33165 TDA1308T/N1 (Dual OpAmp)

7300© 9322 142 72685 TC75W51FU (Dual OpAmp)
 7301© 9351 750 10118 74LV4066PW (Quad Bilateral Switches)
 7302© 9322 142 97668 TA2120FN (Headphone Amplifier)
 7400© 3103 308 84290 TMP86CM29LF-AZT9240.1 (µP)
 7401© 9322 154 05685 TC75W58FU (Dual Comparator)

7402© 9351 750 10118 74LV4066PW (Quad Bilateral Switches)
 7403© 9322 143 49668 M24C01-RDW6 (EEPROM)
 7800© 4822 209 17286 TZA1024T/N1 (HF-Amplifier)
 7830© 9352 641 80557 SAA7324H/M2B (CD10 Signal Proc.)
 7880© 9322 142 87671 SM5903BF (DRAM Controller)

7881© 9322 138 26668 MSM51V17405D-60TS-K (DRAM16Mbit)